

Realizing Richard Feynman's Dream of a Quantum Simulator

*Exploring and Controlling Quantum Matter
using Ultracold Atoms*

IB, Paco-Yndurain Lecture



www.quantum-munich.de

Overview

Motivation

Matter as a Wave

The Path to Ultracold Quantum Matter

Optical Crystal Formed by Laser Light

Applications

Outlook

- **Understand and Design Quantum Materials** - one of the biggest challenge of Quantum Physics in the 21st Century

- **Technological Relevance**

High-Tc Superconductivity (Power Delivery)

Magnetism (Storage, Spintronics...)

Novel Quantum Sensors (Precision Detectors)

Quantum Technologies

(Quantum Computing, Metrology, Quantum Sensors,...)

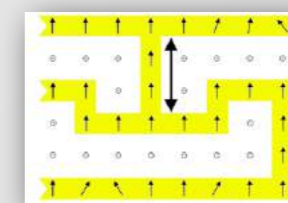
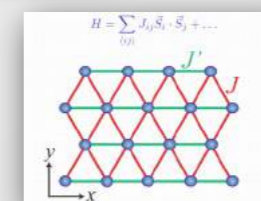
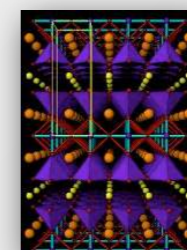

Many cases: lack of basic understanding of underlying processes

Difficulty to separate effects: probe impurities, complex interplay, masking of effects...

Many cases: even simple models “not solvable”

Need to synthesize new material **to analyze effect of parameter change**



the 'ultimate' hard drive

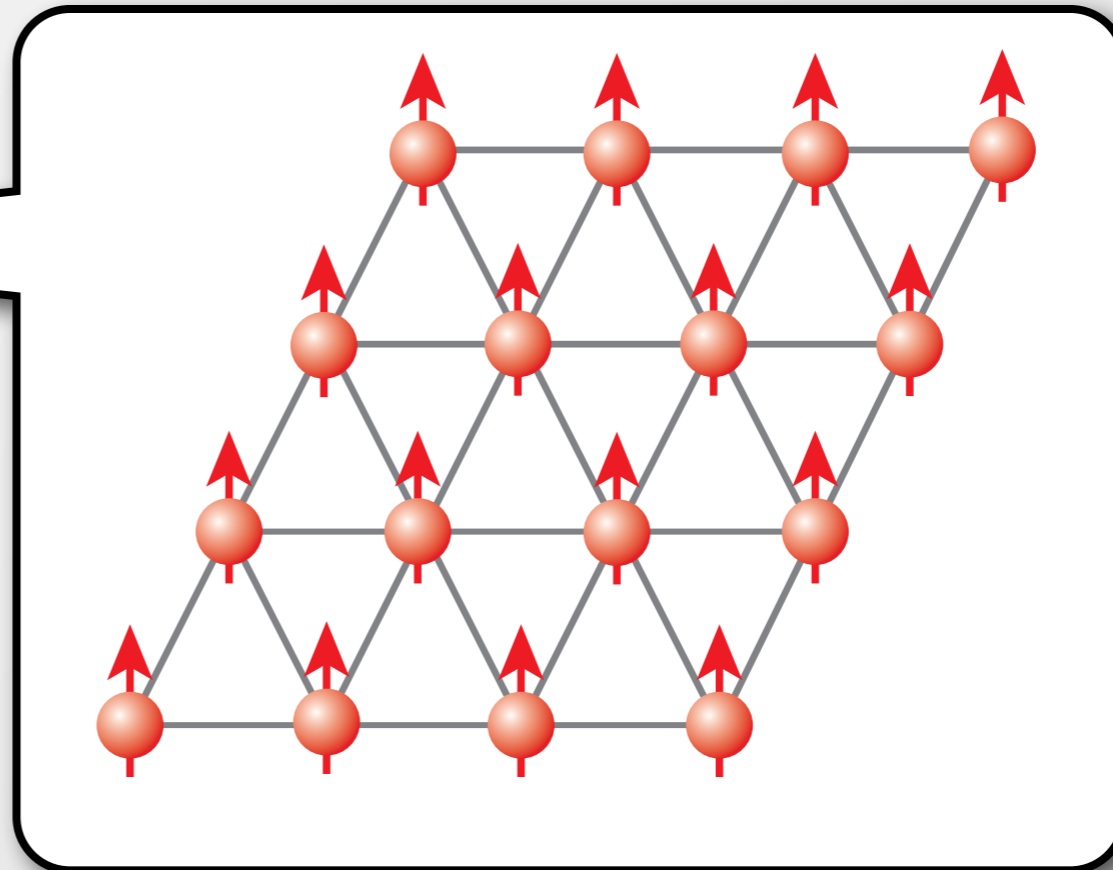

Crystal of spins

the 'ultimate' hard drive

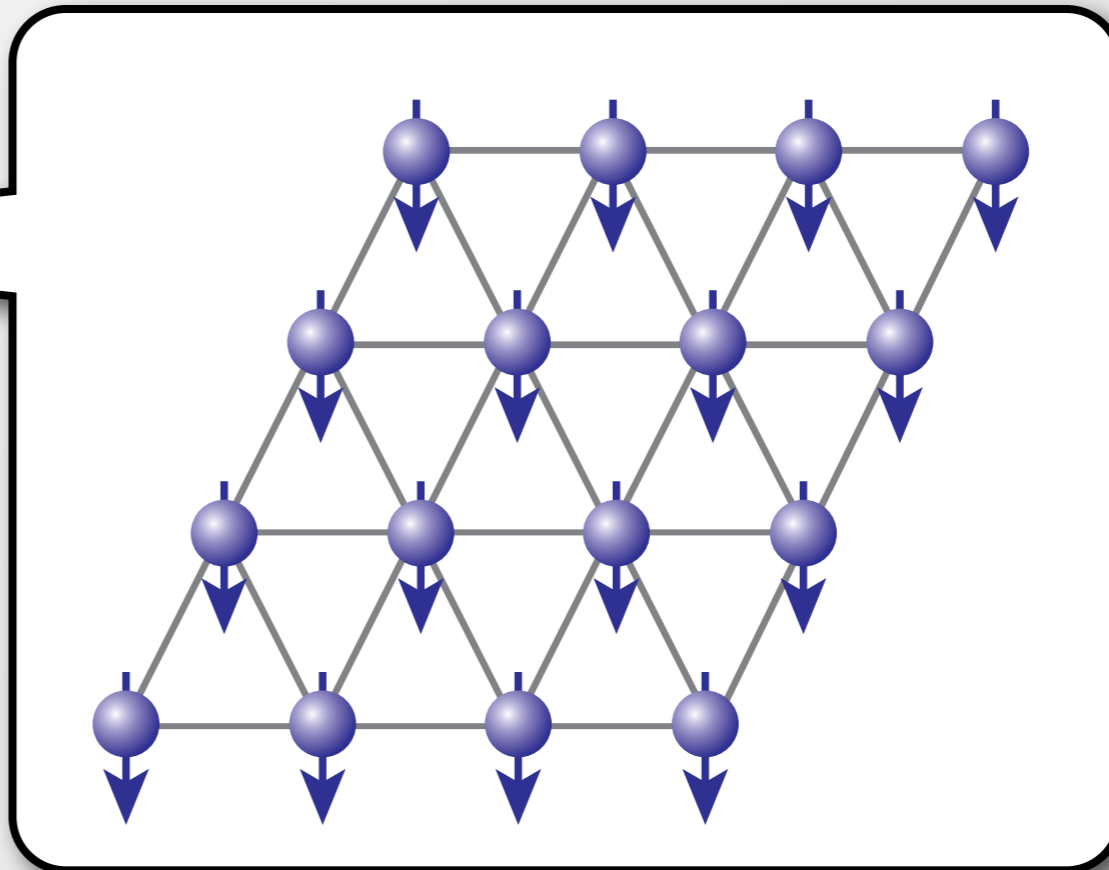

Crystal of spins

the 'ultimate' hard drive

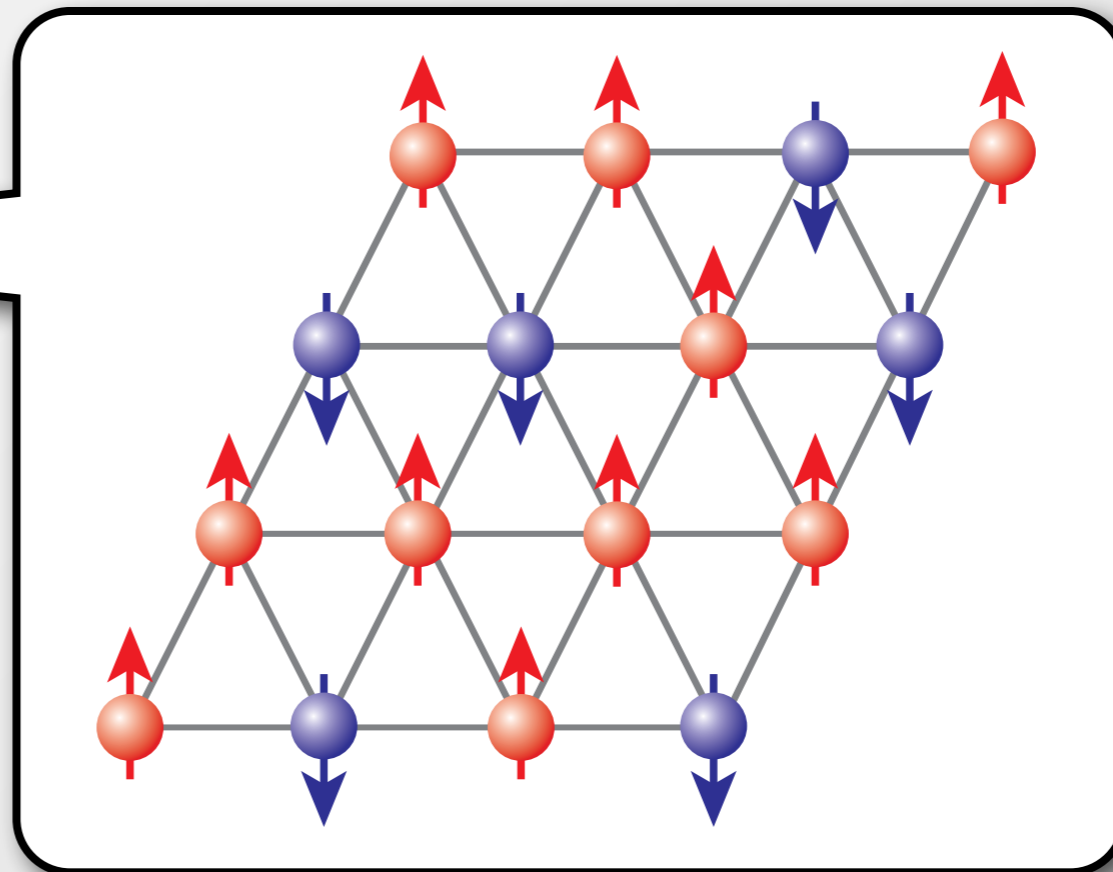

Crystal of spins

$$|\Psi\rangle = c_1 \left| \begin{array}{c} \uparrow \uparrow \uparrow \uparrow \\ \uparrow \uparrow \uparrow \\ \uparrow \uparrow \\ \uparrow \end{array} \right\rangle + c_2 \left| \begin{array}{c} \uparrow \uparrow \uparrow \uparrow \\ \uparrow \uparrow \downarrow \uparrow \\ \uparrow \uparrow \uparrow \\ \uparrow \uparrow \downarrow \uparrow \end{array} \right\rangle + \dots + c_{2^N} \left| \begin{array}{c} \downarrow \downarrow \downarrow \downarrow \\ \downarrow \downarrow \downarrow \\ \downarrow \downarrow \\ \downarrow \end{array} \right\rangle$$

AND AND AND

2^N Configurations simultaneously!

$$|\Psi\rangle = c_1 \left| \begin{array}{c} \uparrow \uparrow \uparrow \uparrow \\ \uparrow \uparrow \uparrow \\ \uparrow \uparrow \\ \uparrow \end{array} \right\rangle + c_2 \left| \begin{array}{c} \uparrow \uparrow \uparrow \uparrow \\ \uparrow \uparrow \downarrow \uparrow \\ \uparrow \uparrow \uparrow \\ \uparrow \uparrow \downarrow \uparrow \end{array} \right\rangle + \dots + c_{2^N} \left| \begin{array}{c} \downarrow \downarrow \downarrow \downarrow \\ \downarrow \downarrow \downarrow \\ \downarrow \downarrow \\ \downarrow \end{array} \right\rangle$$

AND AND AND

2^N Configurations simultaneously!

Roadrunner – Los Alamos



1.1 Petaflops/s
2000 t
3.9 MW

State of the art: < 40 spins ($2^{40} \times 2^{40}$) (what does it take to simulate 300 spins ?)

each doubling allows for one more spin 1/2 only

2^{300} estimated number of protons in the universe

Control of single and few particles

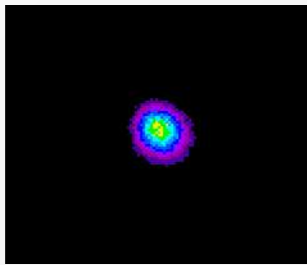

Single Atoms and Ions

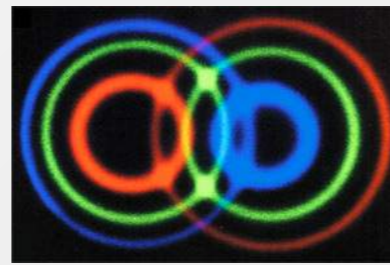

Photons



The Challenge of Many-Body Quantum Systems

Control of single and few particles

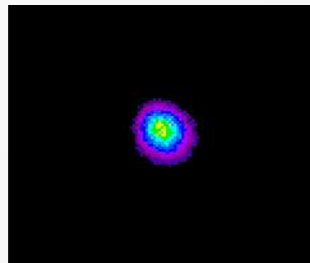

Single Atoms and Ions

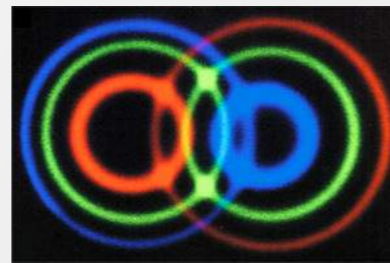

Photons



D. Wineland

S. Haroche

Challenge: ... towards ultimate control of many-body quantum systems



R. P. Feynman's Vision

A *Quantum Simulator* to study the dynamics of another quantum system.

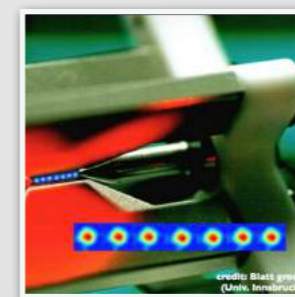

Ion Traps
(R. Blatt, Innsbruck)

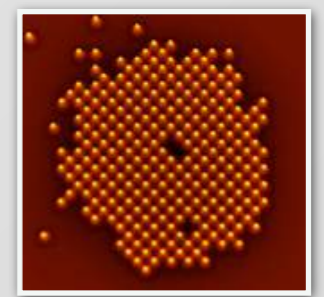

Crystal of Atoms
Bound by Light

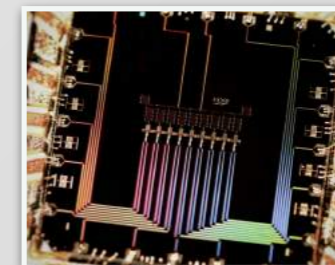

Superconducting
Devices
(J. Martinis, UCSB,
Google)

Control of single and few particles

Simulating Physics with Computers

Richard P. Feynman

Department of Physics, California Institute of Technology, Pasadena, California 91107

Received May 7, 1981

1. INTRODUCTION

On the program it says this is a keynote speech—and I don't know what a keynote speech is. I do not intend in any way to suggest what should be in this meeting as a keynote of the subjects or anything like that. I have my own things to say and to talk about and there's no implication that anybody needs to talk about the same thing or anything like it. So what I want to talk about is what Mike Dertouzos suggested that nobody would talk about. I want to talk about the problem of simulating physics with computers and I mean that in a specific way which I am going to explain. The reason for doing this is something that I learned about from Ed Fredkin, and my entire interest in the subject has been inspired by him. It has to do with learning something about the possibilities of computers, and also something about possibilities in physics. If we suppose that we know all the physical laws perfectly, of course we don't have to pay any attention to computers. It's interesting anyway to entertain oneself with the idea that we've got something to learn about physical laws; and if I take a relaxed

Sing

Challen



haroche

ystems

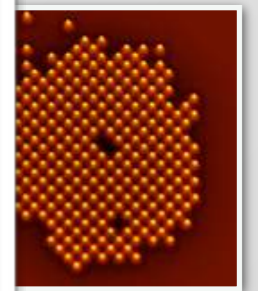

ystal of Atoms
ound by Light

conducting
Devices

rtinis, UCSB,
Google)

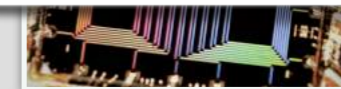

Control of single and few particles

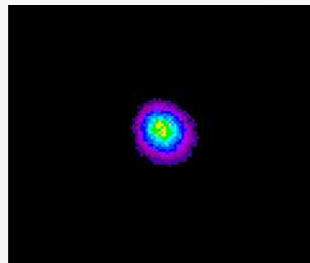

Single Atoms and Ions

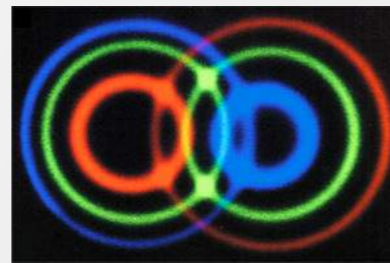

Photons



D. Wineland

S. Haroche

Challenge: ... towards ultimate control of many-body quantum systems



R. P. Feynman's Vision

A *Quantum Simulator* to study the dynamics of another quantum system.



Ion Traps
(R. Blatt, Innsbruck)

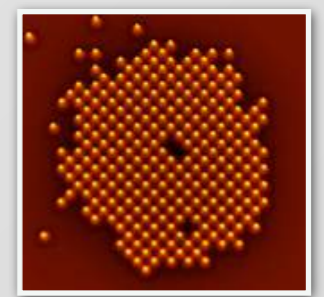

Crystal of Atoms
Bound by Light

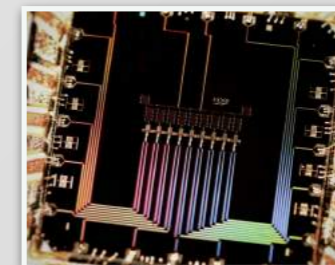

Superconducting
Devices
(J. Martinis, UCSB,
Google)

Ultracold Quantum Gases



**Deborah Jin
(1968-2016)**



University of
Colorado at Boulder



University of
Colorado at Boulder



EPA/PRB

**Centennial Nobel Prize
in Physics! (2001)**

**Original lab book entry from
W. Ketterle!**

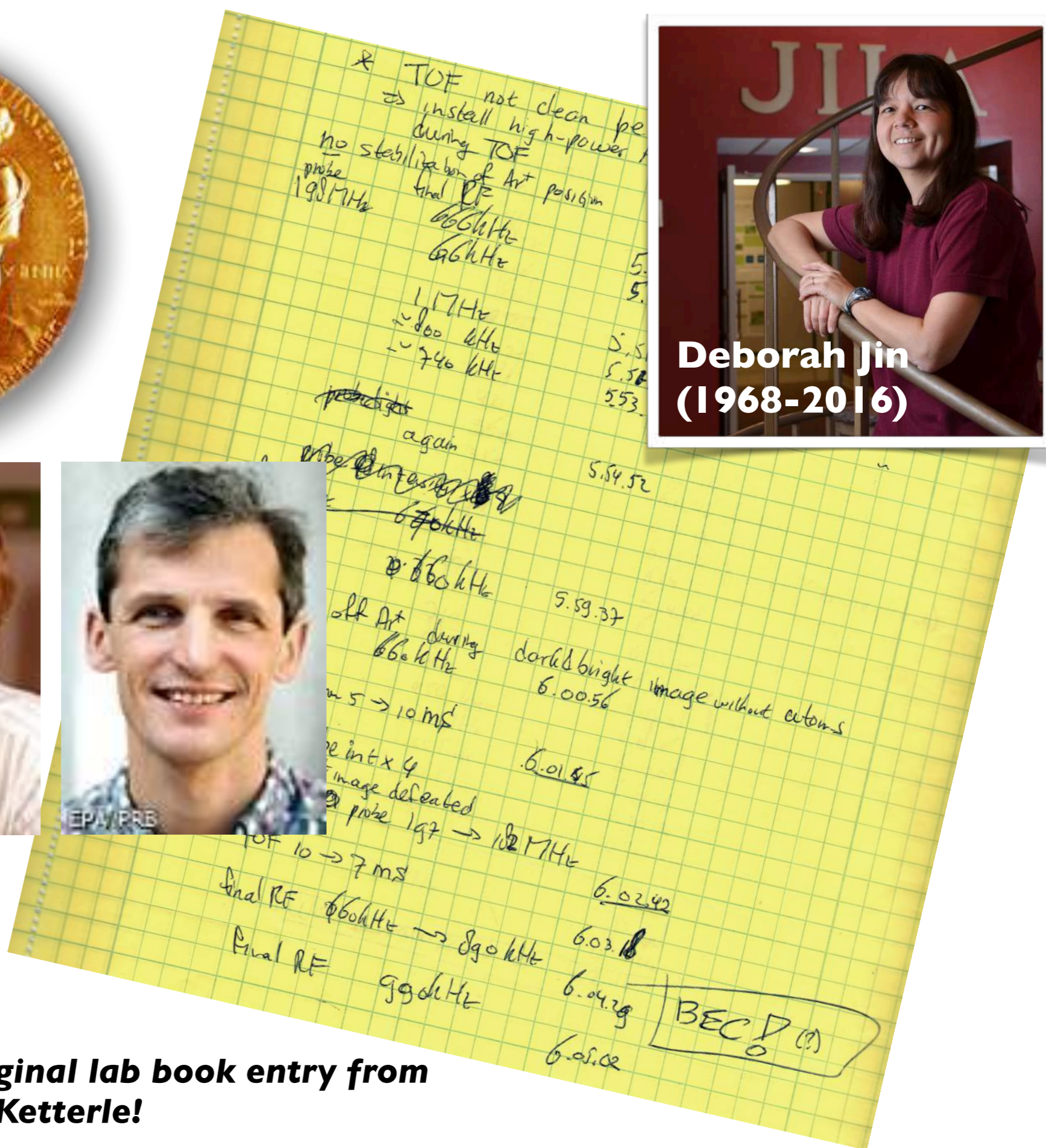

* TOF not clean pe
=> install high-power
during TOF
no stabilization of Art position
probe 198 MHz
final RF 660 kHz
660 kHz

1.17 Hz
~ 800 kHz
~ 740 kHz

probe
again

5.54.52

660 kHz

5.59.37

off Art during
660 kHz

dark/bright image without contours
6.00.56

5 -> 10 ms

6.01.55

re int x 4
image defeated
probe 197 -> 102 MHz

TOF 10 -> 7 ms

6.02.42

final RF 660 kHz -> 890 kHz

6.03.18

final RF 890 kHz

6.04.29

BEC D(?)

6.05.02

Molybdändisulfid

Schwefelatome unter dem Rastertunnelmikroskop

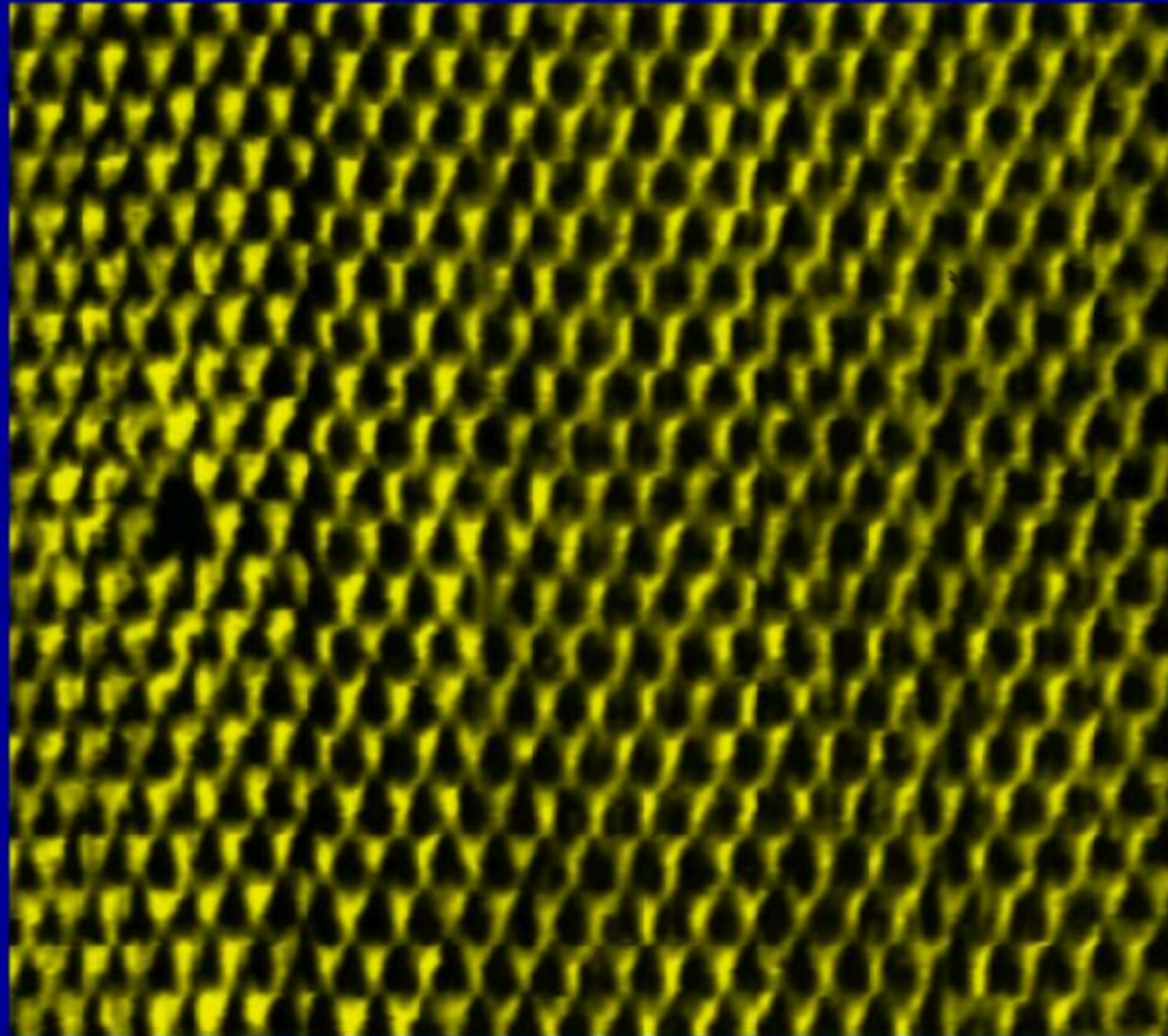

What is Matter ?



**Louis-Victor
de Broglie**
(1892-1987)

$$\lambda = \frac{h}{p} = \frac{h}{mv}$$

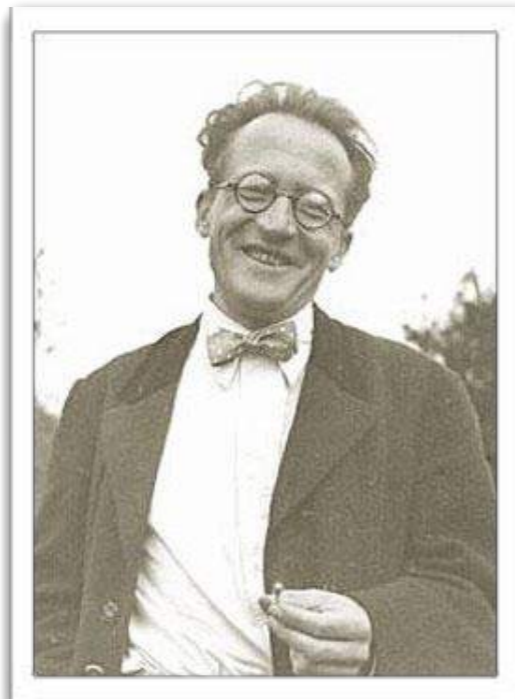

**Erwin
Schrödinger**
(1887-1961)

$$i\hbar \frac{\partial \Psi}{\partial t} = H\Psi$$



What characterizes a wave ?

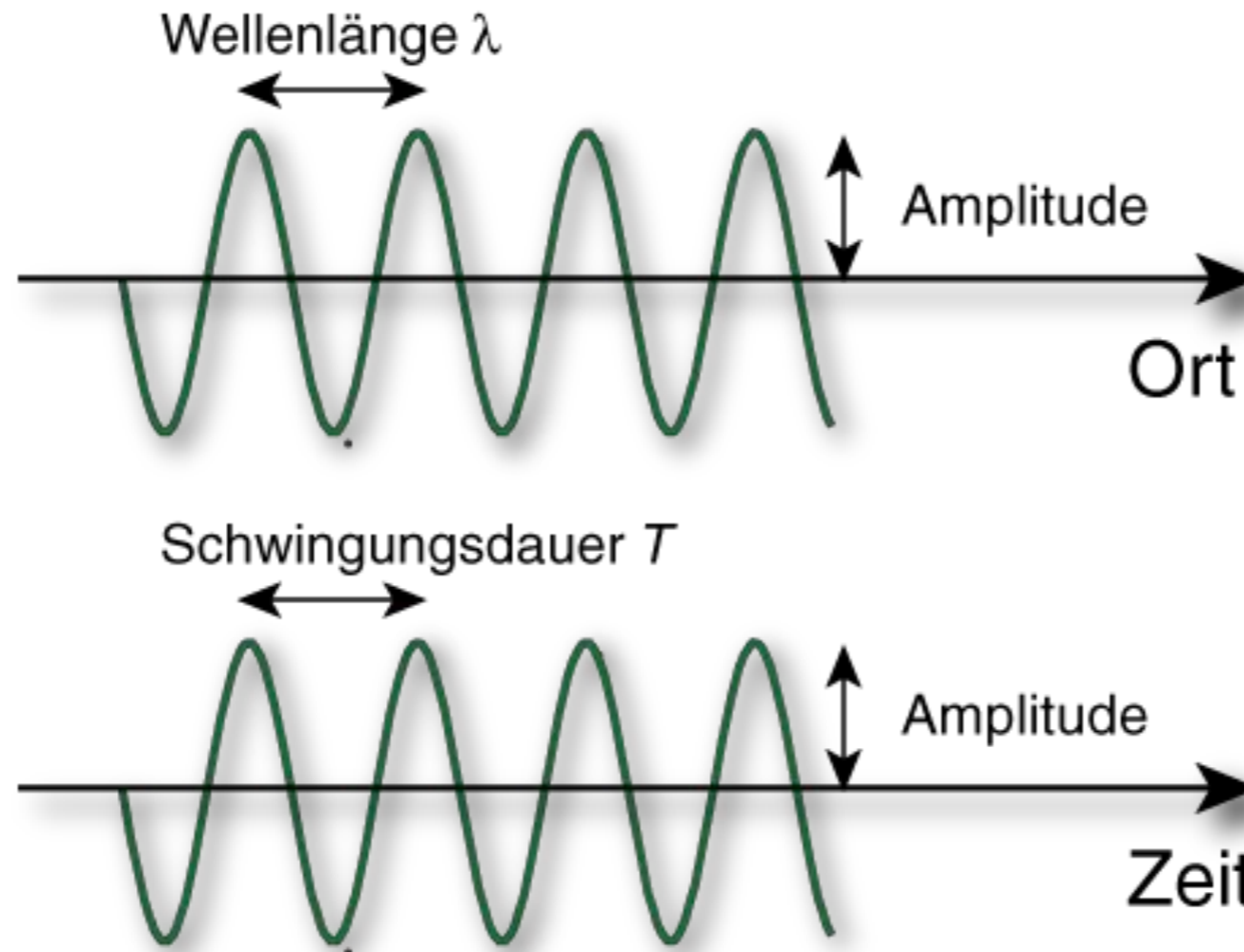

Wave is a periodic oscillation in space and time !

Frequency (Oscillations per s)

$$\nu = 1/T$$

Propagation velocity:

$$c = \lambda \cdot \nu$$

1+1=2? or not ?

Matter



+

Matter



=

Twice as much matter



Superposition Principle for Waves

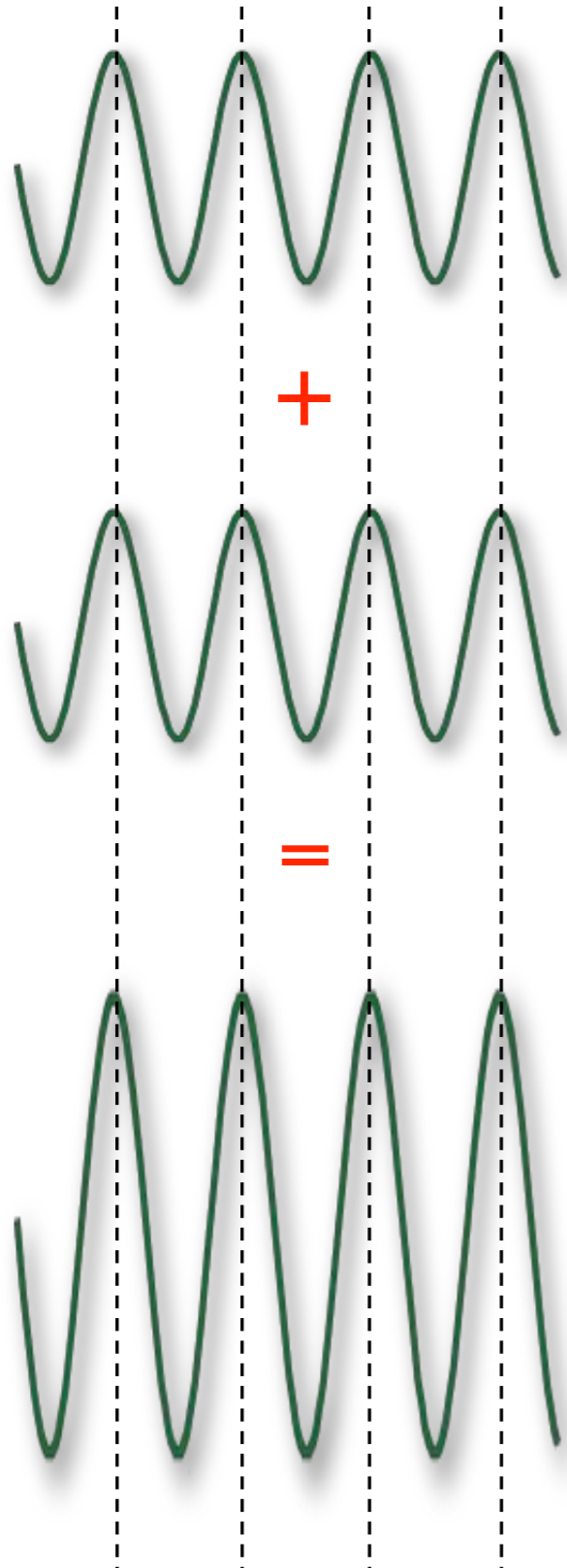

Waves can enhance each other!

constructive interference when two waves are added in phase

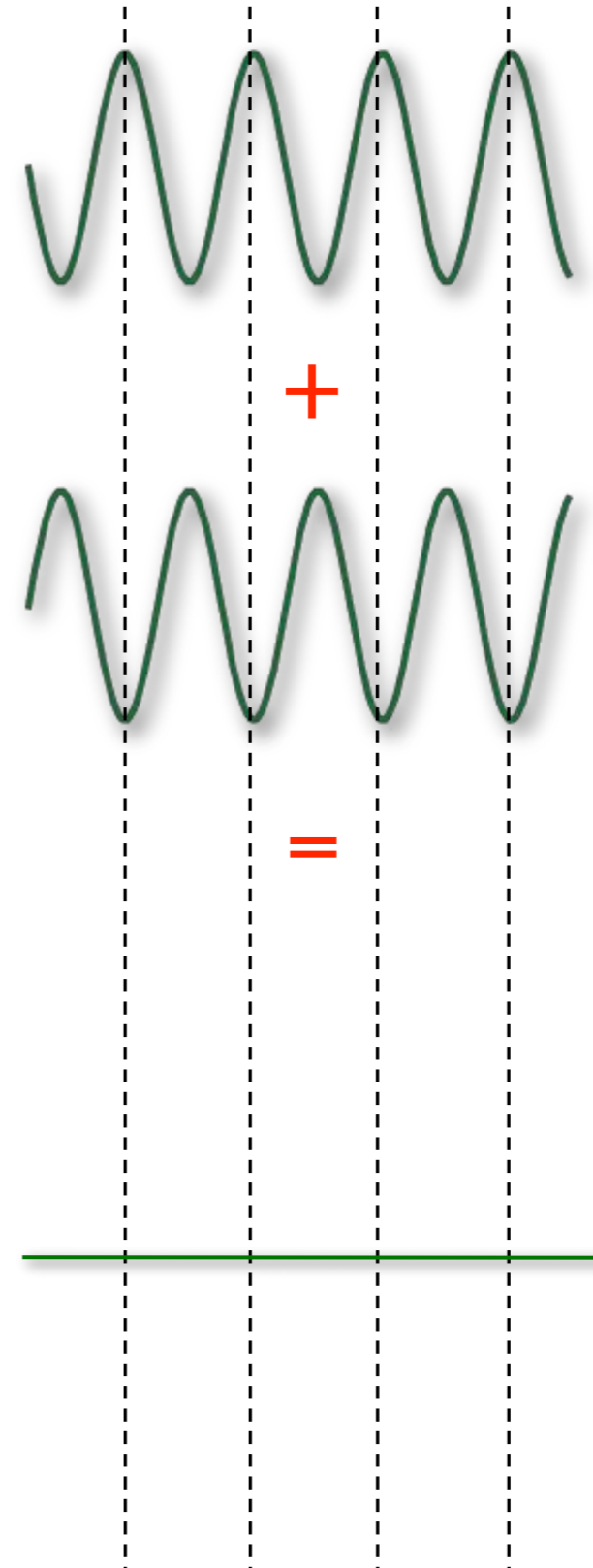

Waves can eliminate each other!

destructive interference when two waves are added $\lambda/2$ out of phase

Go To Interference Program...

When can we perceive this wave character?

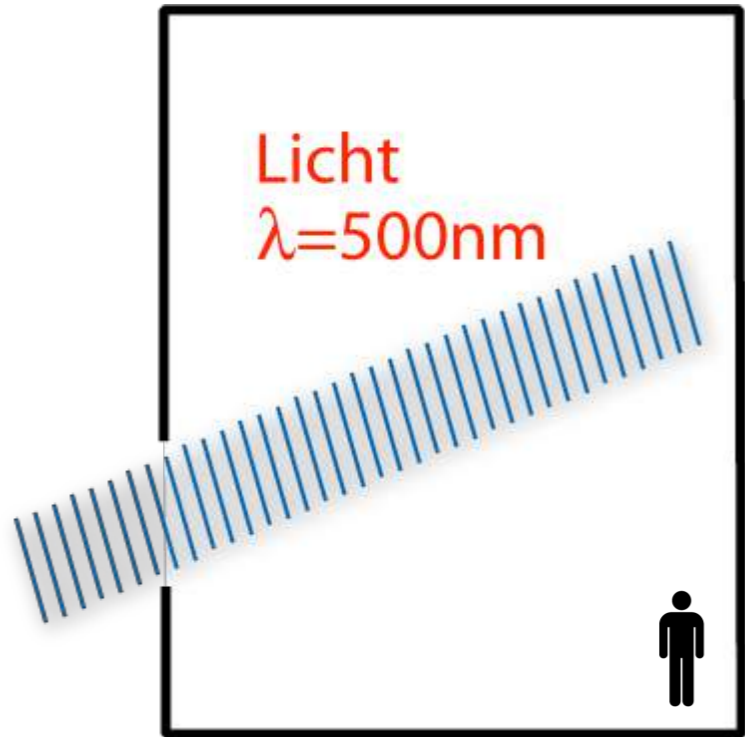

$\lambda \ll \text{Size of Object}$

Propagation along
straight lines

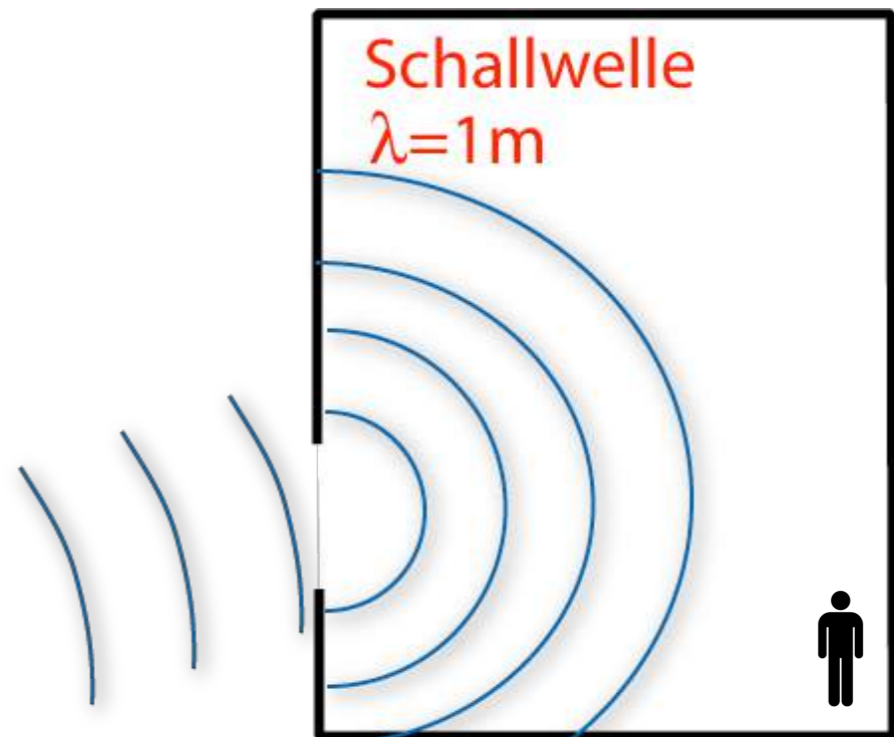

$\lambda \approx \text{Size of Object}$

Waves are
diffracted!

Objekt	m (kg)	v (m/s)	λ (mm)
Elektron	$9,1 \cdot 10^{-31}$	$2 \cdot 10^6$	$4 \cdot 10^{-7}$ (0,00000004)
Neutron	$1,7 \cdot 10^{-27}$	$4 \cdot 10^3$	$9 \cdot 10^{-8}$ (0,000000009)
⁸⁷ Rb Atom	$1,5 \cdot 10^{-25}$	270	$2 \cdot 10^{-8}$ (0,000000002)
C ₆₀	$1,2 \cdot 10^{-24}$	210	$3 \cdot 10^{-9}$ (0,0000000003)
Fussball	0,5	20	$7 \cdot 10^{-32}$ (0,000000000000000000 000000000000000000 007)

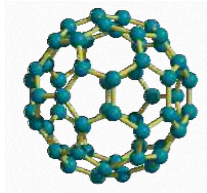
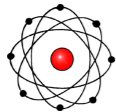

What is interfering in the case of matter waves?

Elektromagnetische Felder

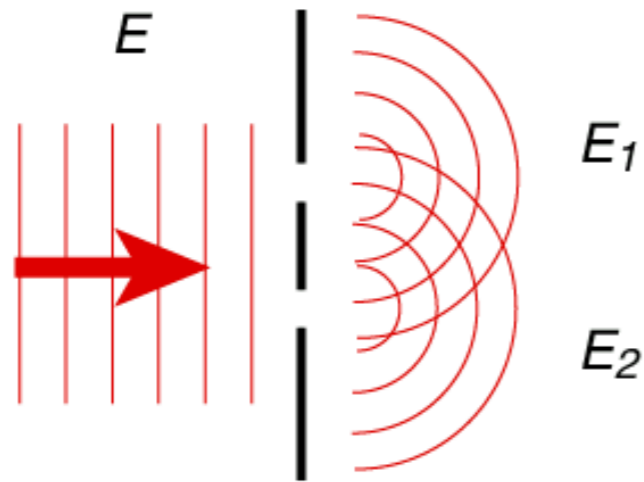

$$E_{det} = E_1 + E_2$$

$$I \propto |E_1 + E_2|^2$$

Quantenmechanische Wellenfunktionen

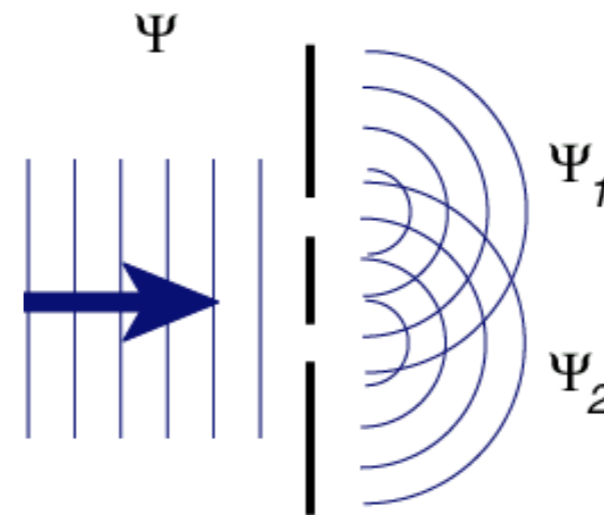

$$\Psi_{det} = \Psi_1 + \Psi_2$$

$$n \propto |\Psi_1 + \Psi_2|^2$$

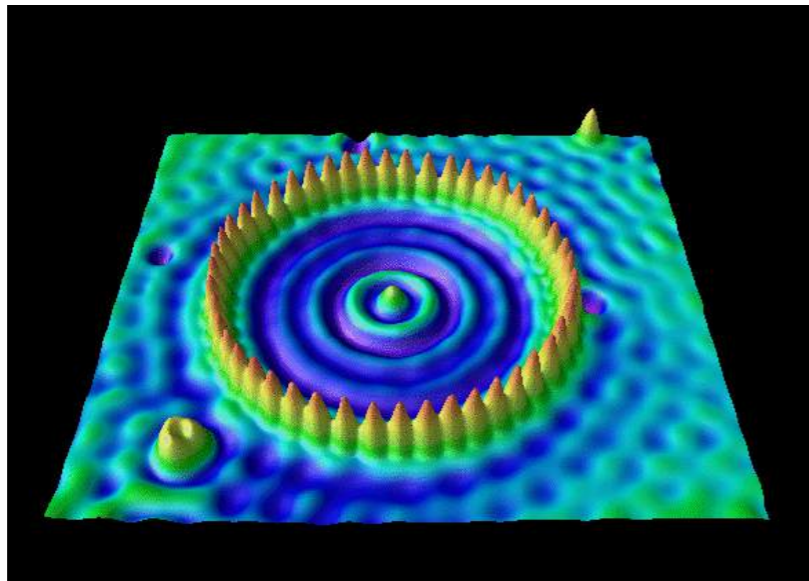

Fe auf Cu (111)

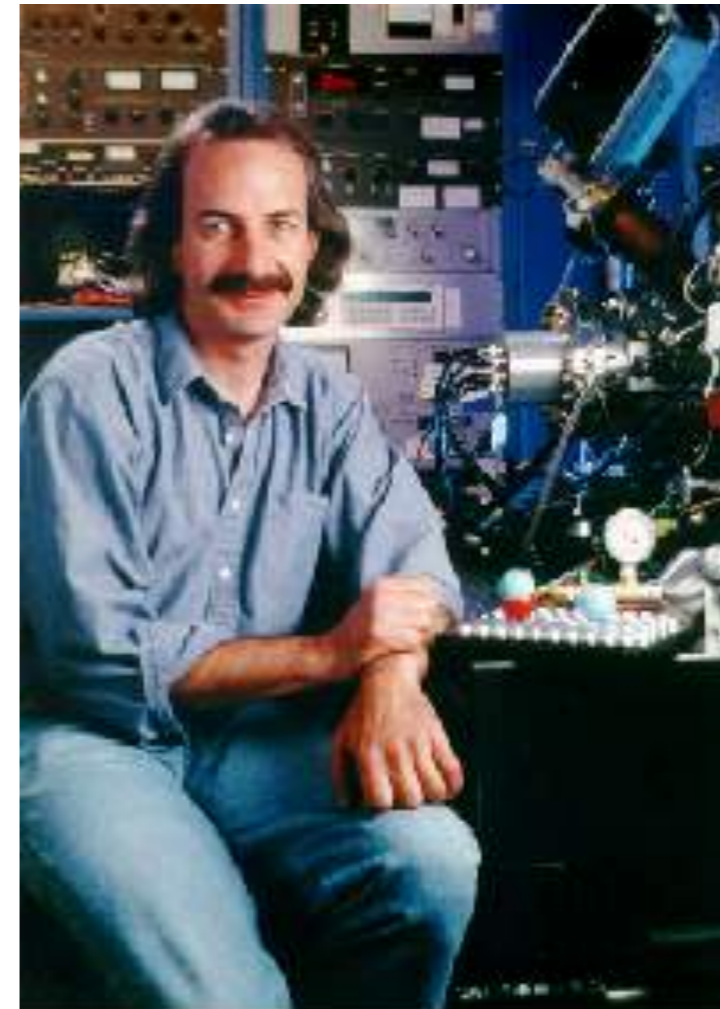
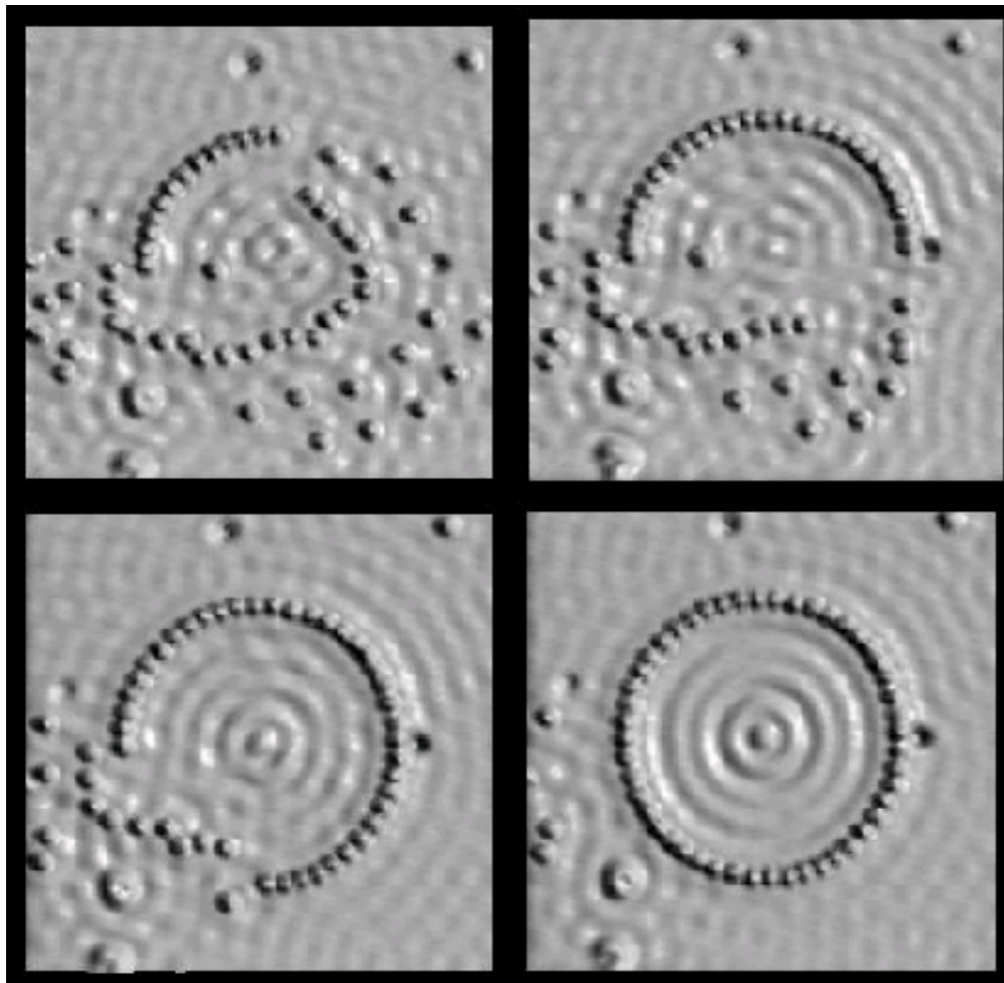

Don Eigler
IBM Almaden Research Labs
<http://www.almaden.ibm.com/vis/stm/>

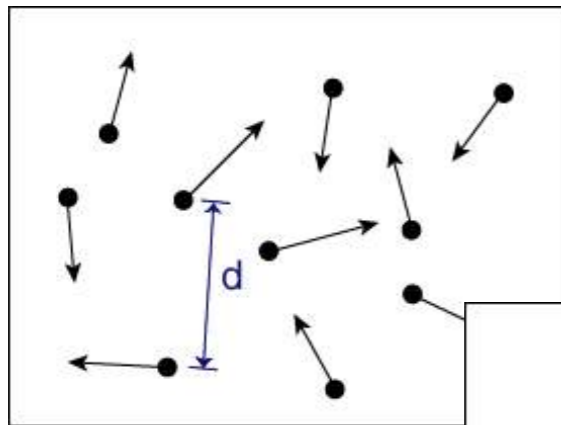

$T \gg T_c$
Classical Gas

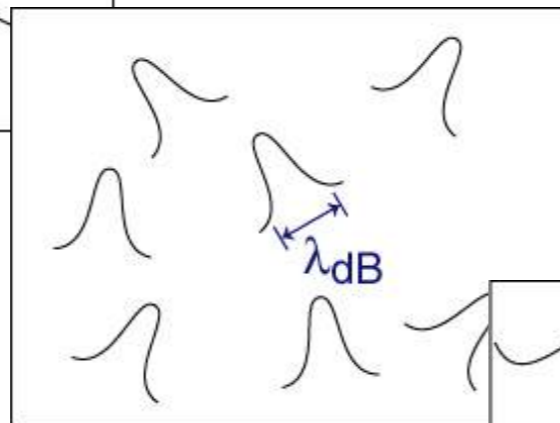

$T > T_c$
 $\lambda_{dB} = h/mv \propto T^{-1/2}$

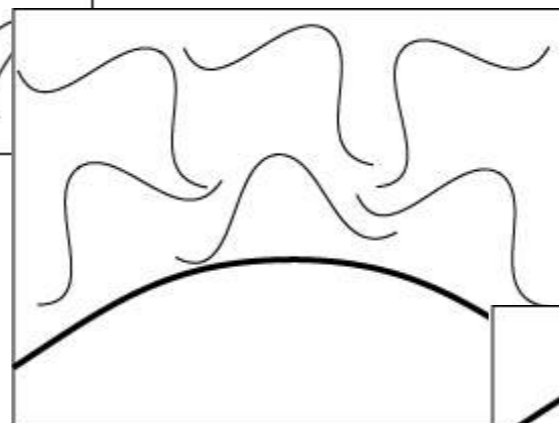

$T < T_c$
 $\lambda_{dB} \approx d$

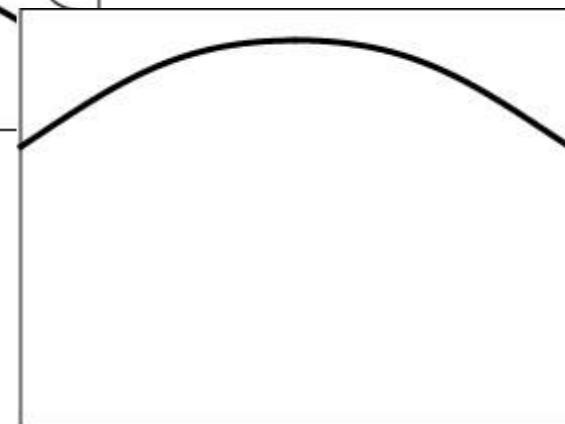

$T = 0$
Coherent
Matter Wave

Predicted 1924...

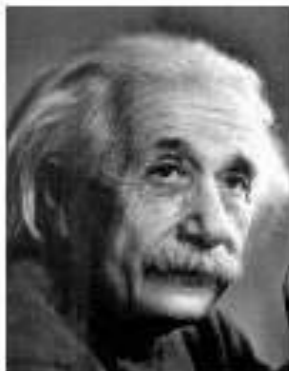

A. Einstein



S. Bose



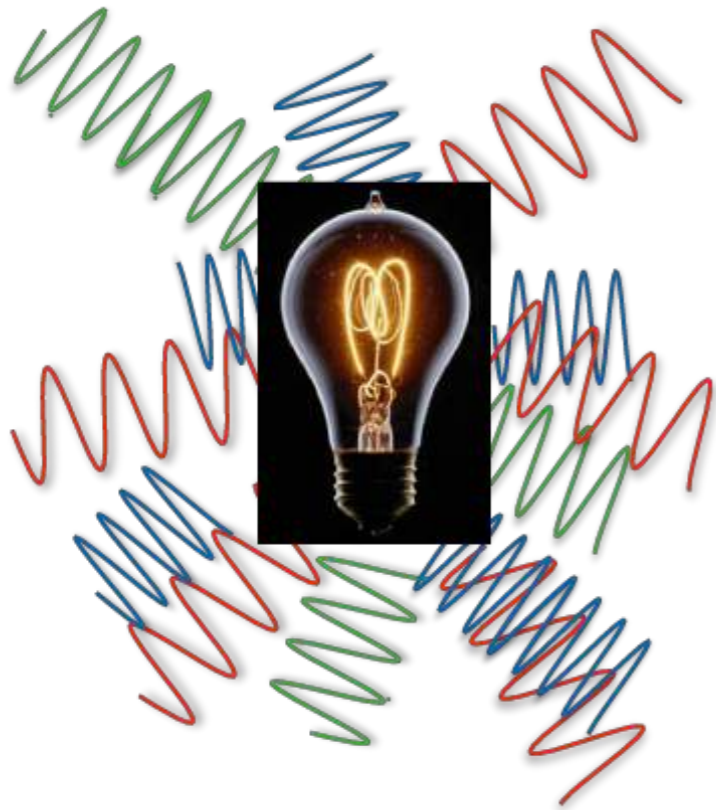

Laser emits one one continuous wavetrain with a perfectly defined frequency!



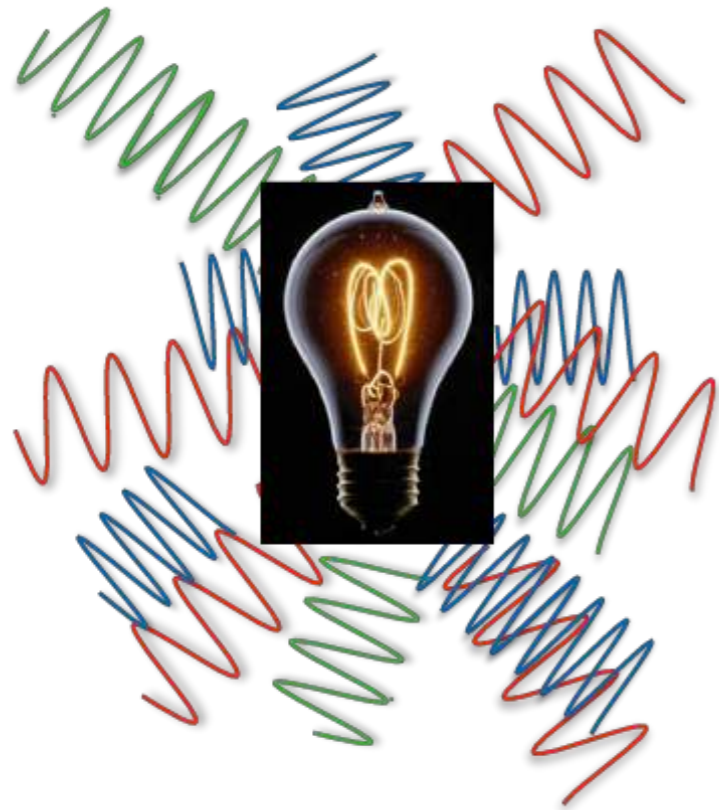

**BEC is for
matter
what the laser
is
for light!**



Laser emits one one continuous wavetrain with a perfectly defined frequency!



Conditions for BEC:

$$n \cdot \lambda^3 \approx 1$$

z.B. Water

For a typical density of water $n_{\text{H}_2\text{O}}$ we obtain $T_c = 1\text{K}$

Problem: Water is a block of ICE @ 1K

Solution: Density has to be lowered by several orders of magnitude to prolong timescale for solid formation!



Conditions for BEC:

$$n \cdot \lambda^3 \approx 1$$

z.B. Water

For a typical density of water $n_{\text{H}_2\text{O}}$ we obtain $T_c = 1\text{K}$

Problem: Water is a block of ICE @ 1K

Solution: Density has to be lowered by several orders of magnitude to prolong timescale for solid formation.

Even lower temperatures are needed!



de Broglie Wavelengths

Thermal deBroglie wavelengths

$$\lambda = \frac{h}{\sqrt{2\pi m k_B T}}$$

273 K (0°C, 32°F)
Water freezes

77K (-197°C, -323°F)
Air liquifies

4K (-269°C, -452 °F)
He liquifies

T (K)

10000

100

1

10⁻¹

10⁻⁴

10⁻⁶

10⁻⁸

de Broglie Wavelengths of a typical atom

0.01 nm

0.1 nm

1 nm

0.01 μm

0.1 μm

1 μm

10 μm

These are temperatures we need to reach to create macroscopic matter waves !

Radiation Pressure

Komet Hale-Bopp

A special way to cool!

Laser Cooling

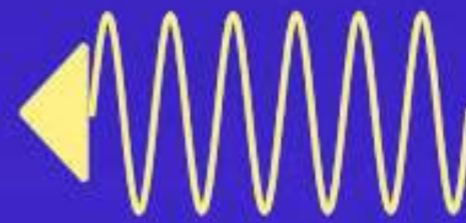

T.W. Hänsch and A.L. Schawlow, Opt. Comm. 13, 68 (1975)

Laser Cooling



Nobel in Physics 1997



Steve Chu



Claude Cohen-Tannoudji



Bill Phillips



Maximum Acceleration

$$a_{\max} = \frac{\hbar k}{m} \times \frac{\Gamma}{2}$$

e.g. for ^{87}Rb

$$a_{\max} = 100000 \text{ m/s}^2$$

Minimum Temperature

$$T_{\min} \approx 10 \mu\text{K}$$



10000 g !



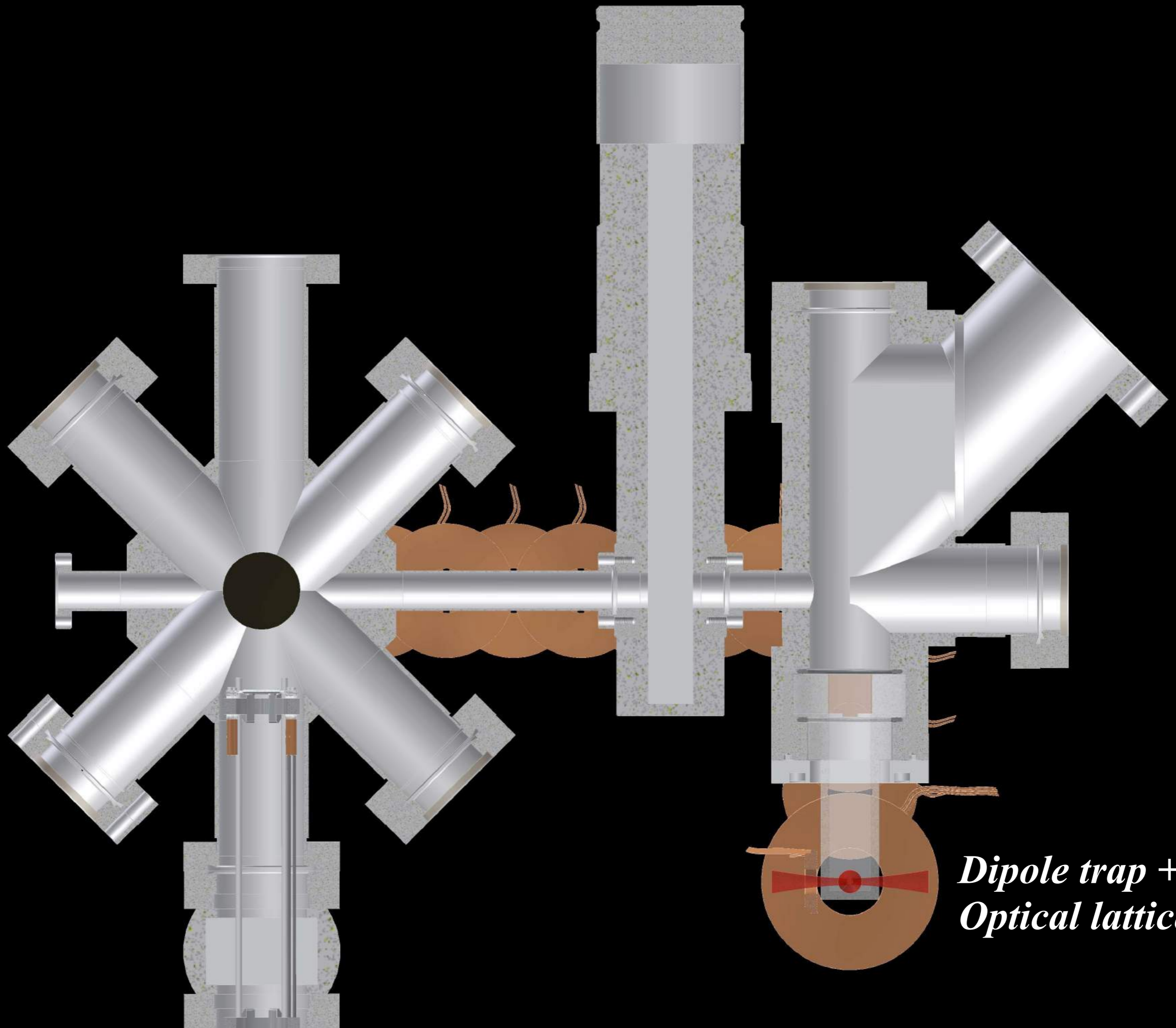

*Dipole trap +
Optical lattices*

Laser Cooling at Work

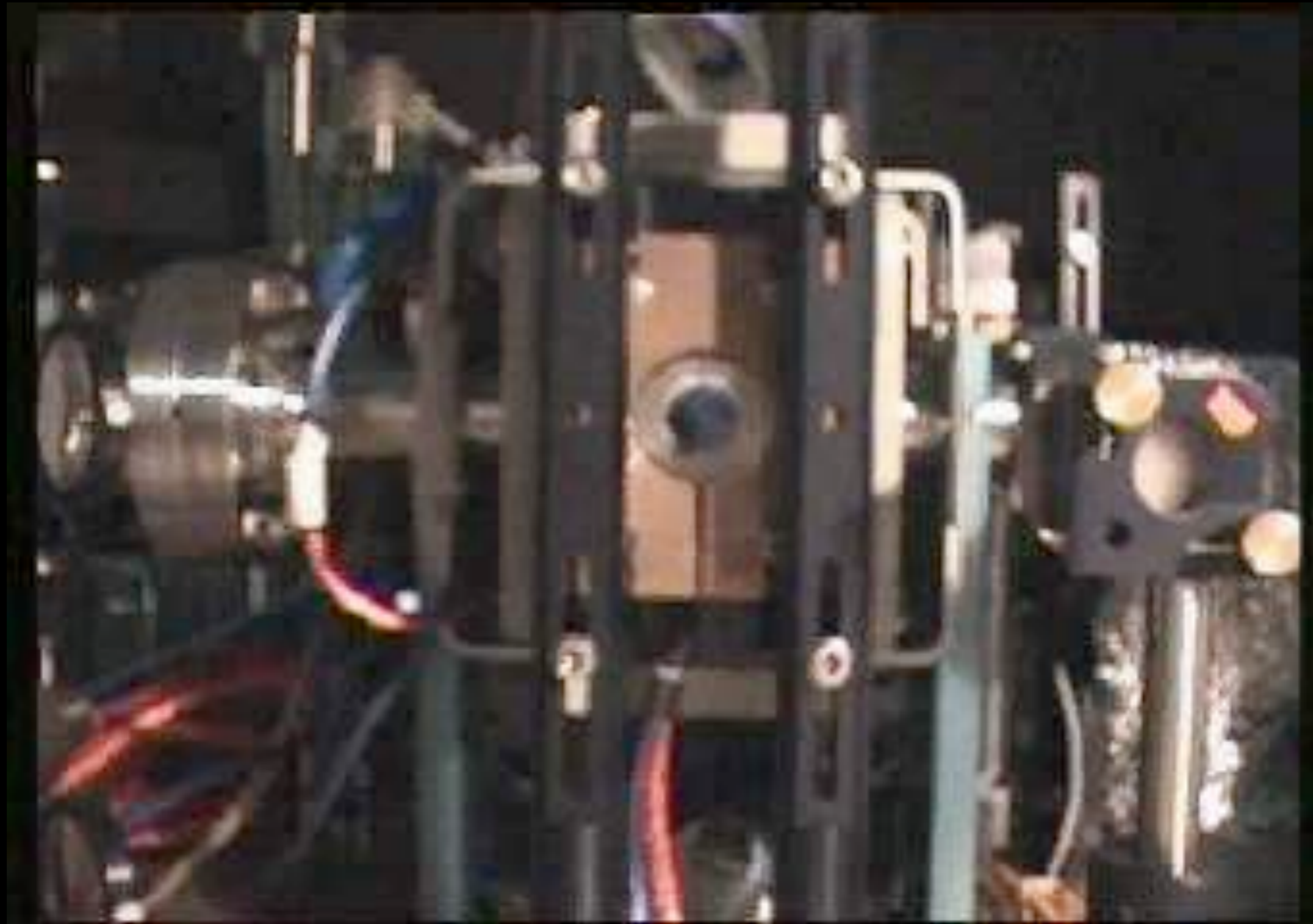

Laser Cooling at Work

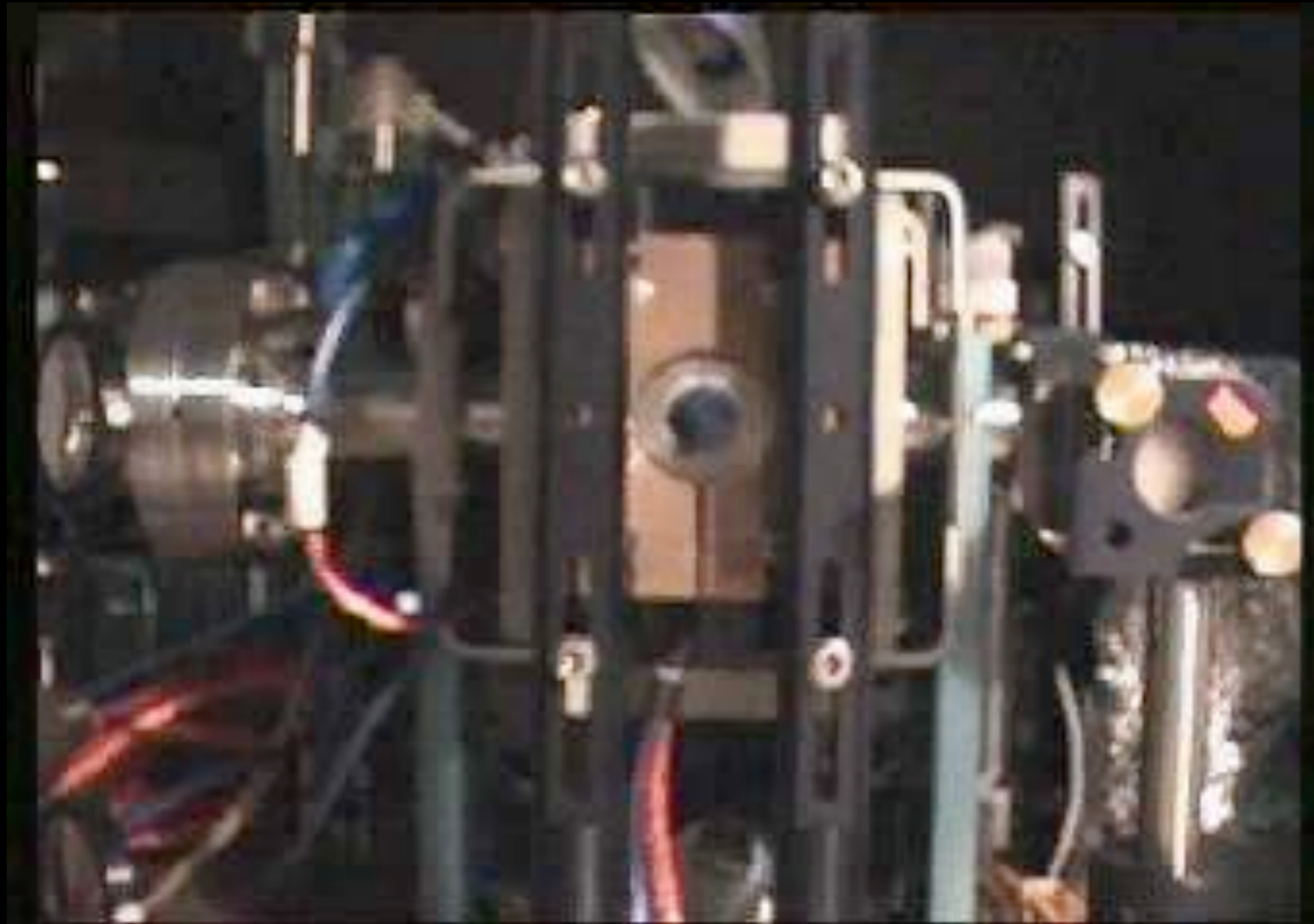

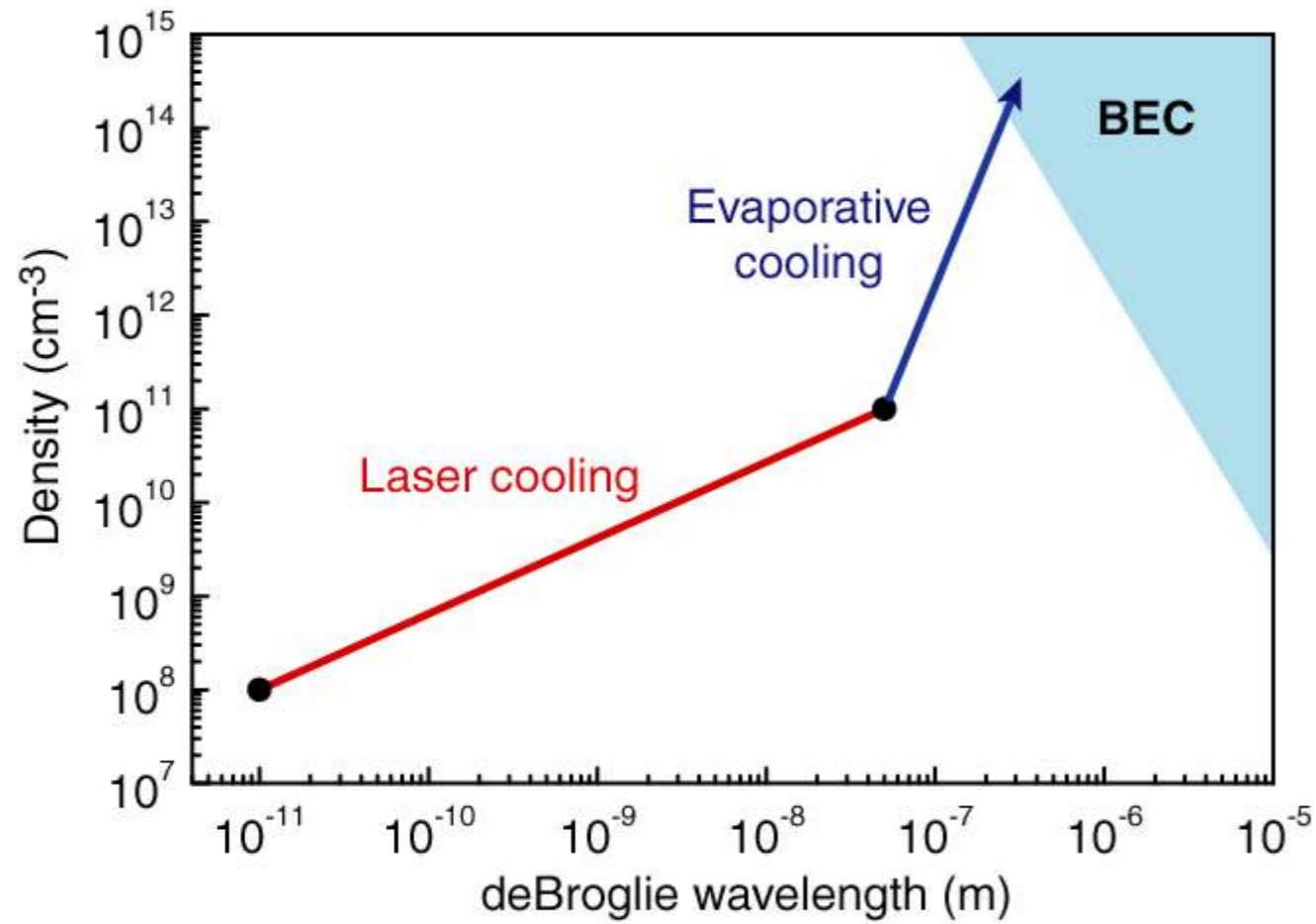

$$n \cdot \lambda^3 \approx 1$$

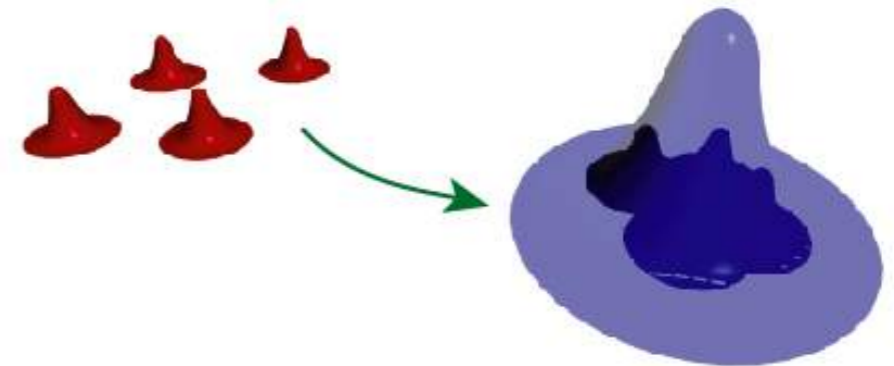



Energy of an atom
in an external magnetic field $E = -\vec{\mu} \cdot \vec{B}$

Force on an atom in an
inhomogeneous magnetic field $\vec{F} = -\mu \cdot \nabla B$

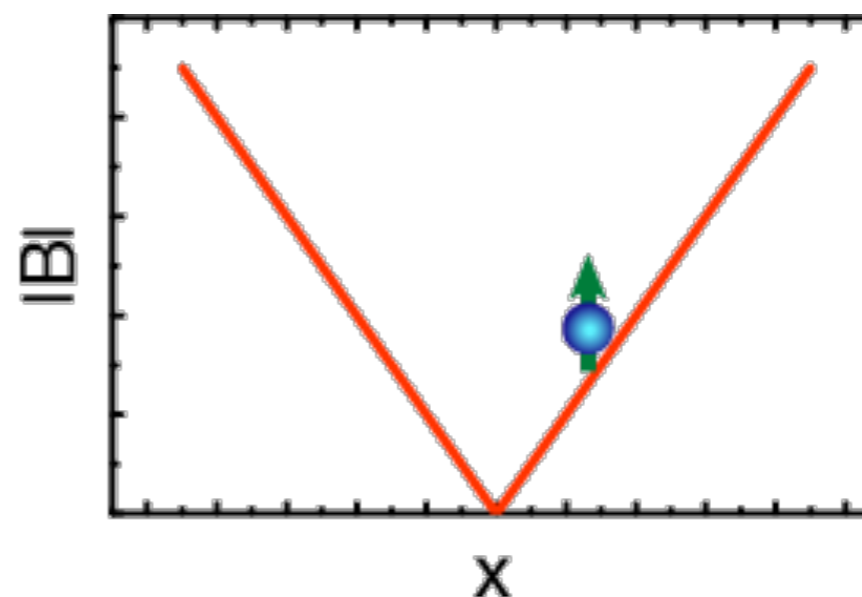
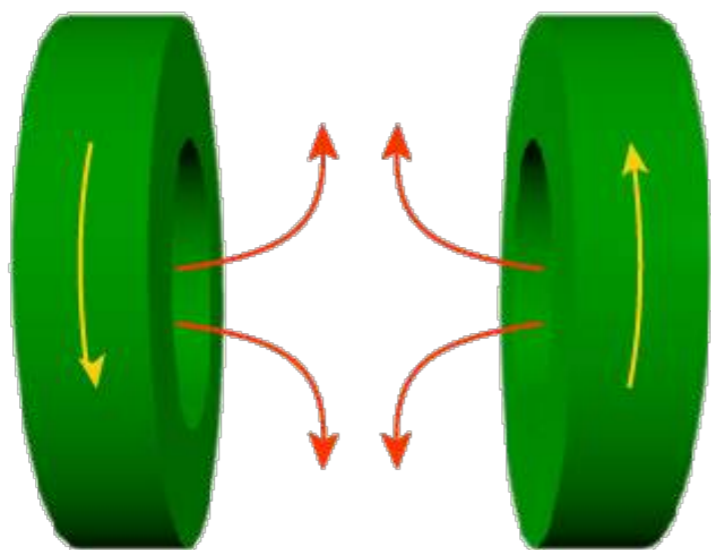

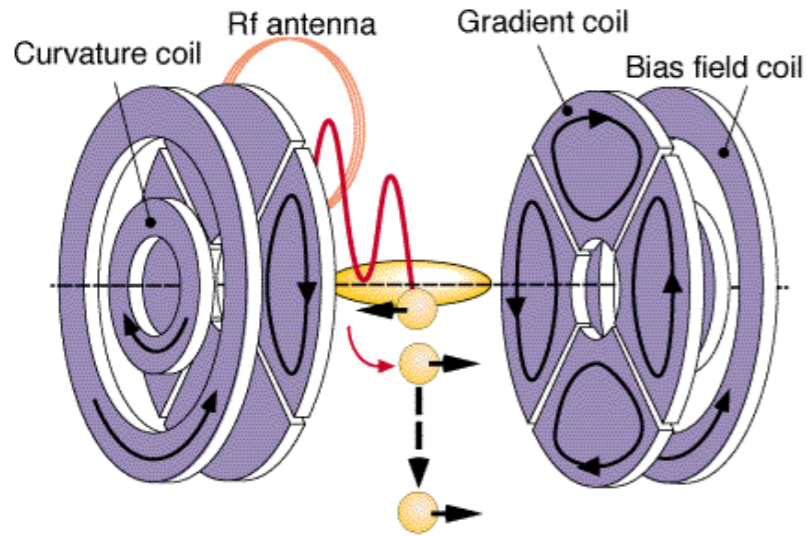

MIT, March '96 [M.-O. Mewes et al., PRL 77, 416 (1996)]

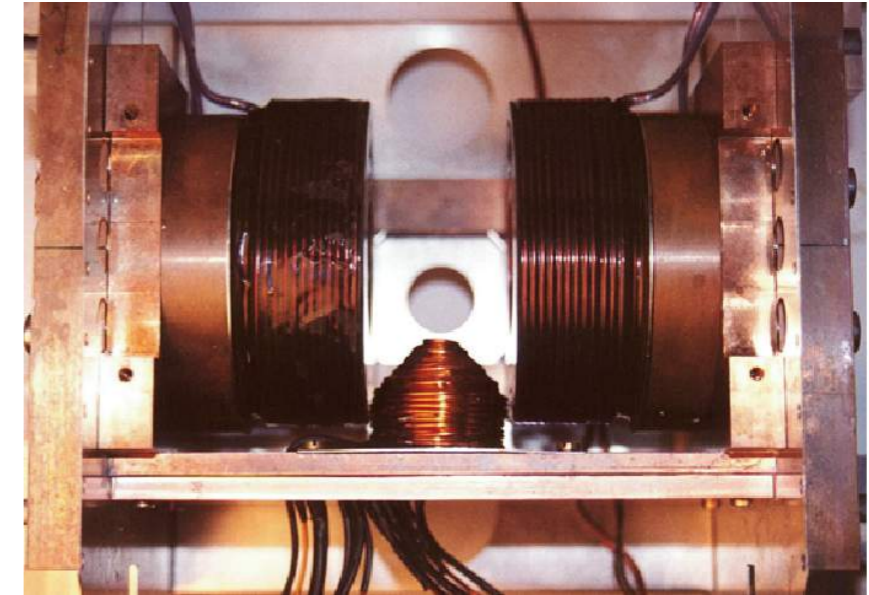

Cloverleaf Trap

QUIC-Trap



Miniaturized Magnetic Traps

Evaporative Cooling

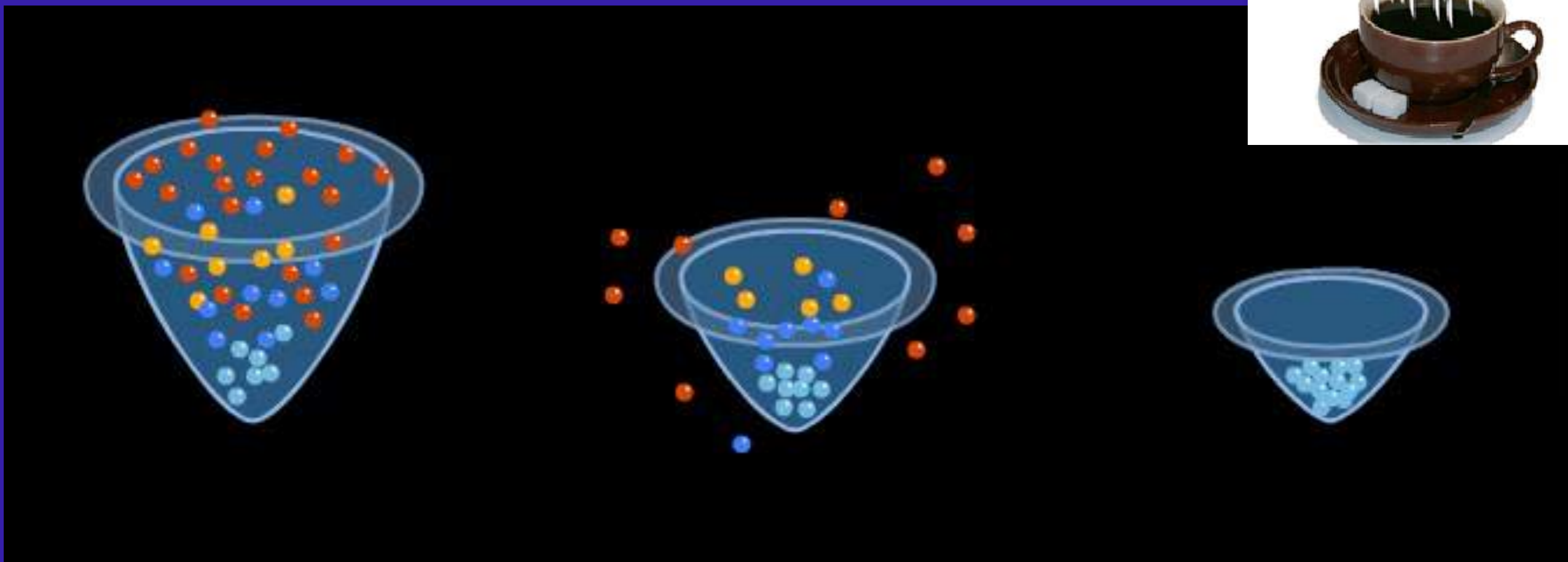

Tom Greytak



Daniel Kleppner

Time-of-Flight Imaging



Time-of-Flight Imaging



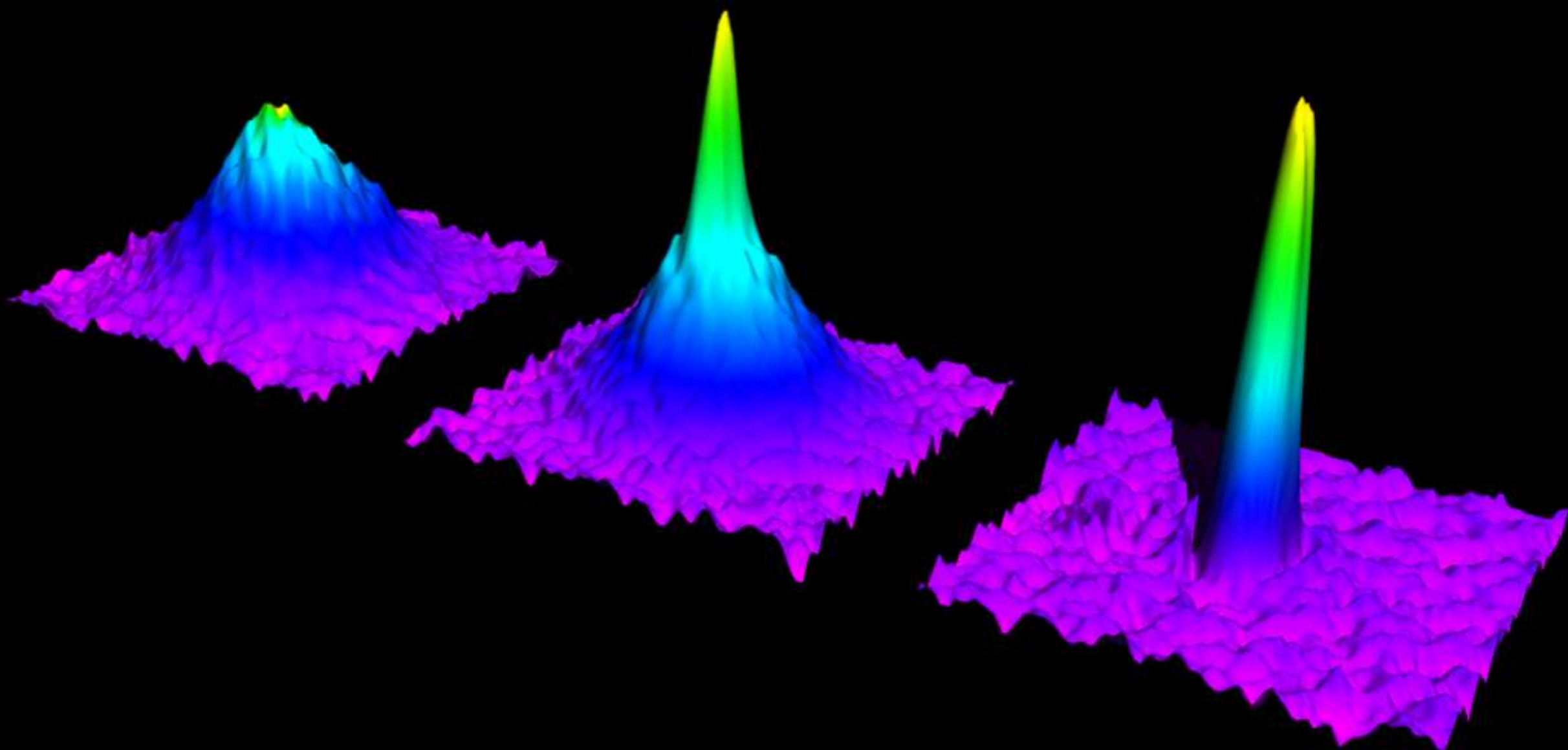

Interference of Two Bose-Einstein Condensates

Trapped BEC's

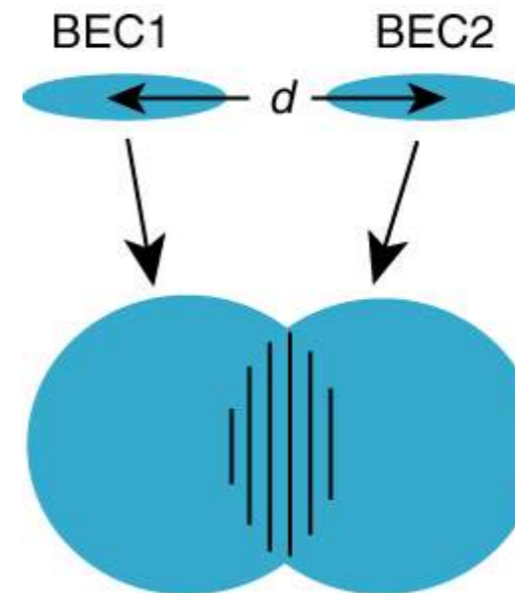

**BEC's after
expansion time t**

$$\lambda = \frac{h}{m\Delta v} = \frac{ht}{md}$$

Interference of Two Bose-Einstein Condensates

Trapped BEC's

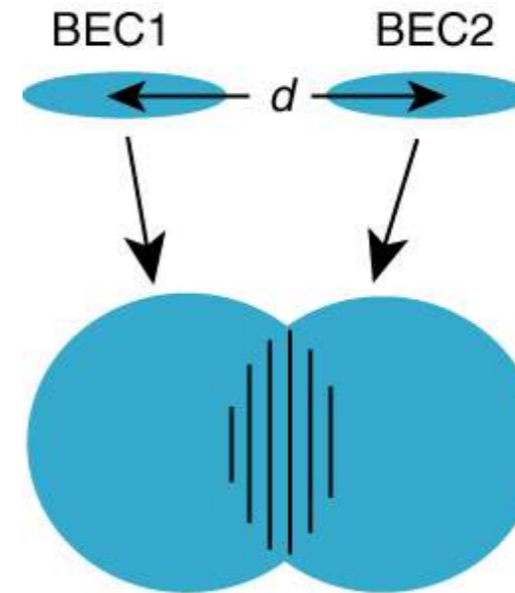

BEC's after expansion time t

$$\lambda = \frac{h}{m\Delta v} = \frac{ht}{md}$$

M. R. Andrews *et. al.*
Science 275, ff. 637, 1997

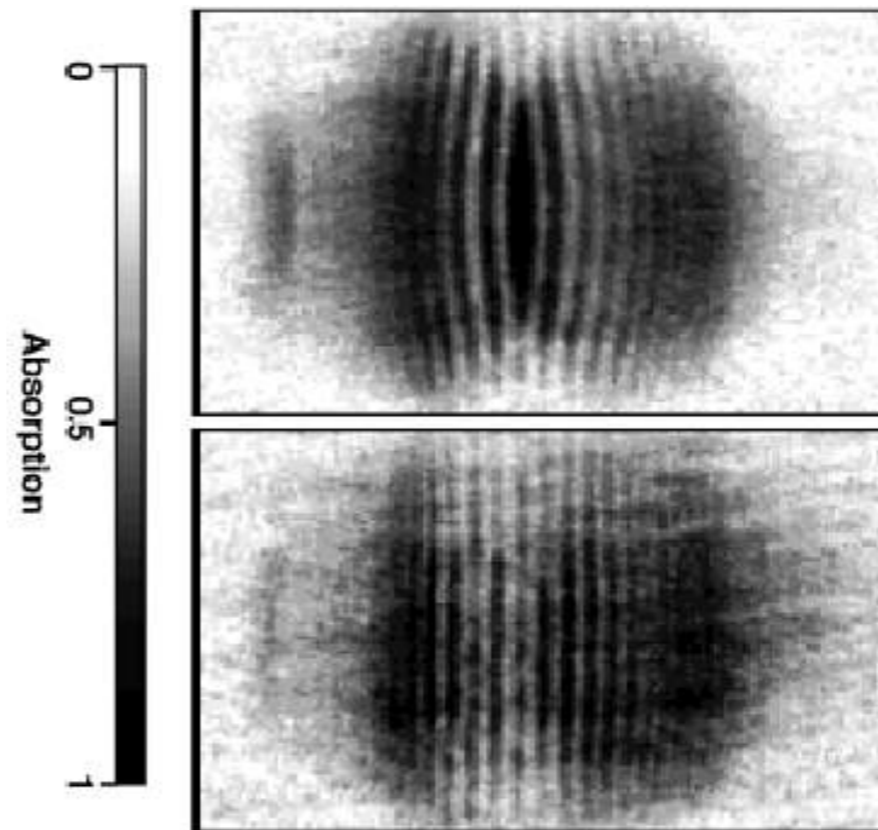

We need a lot
of optics!



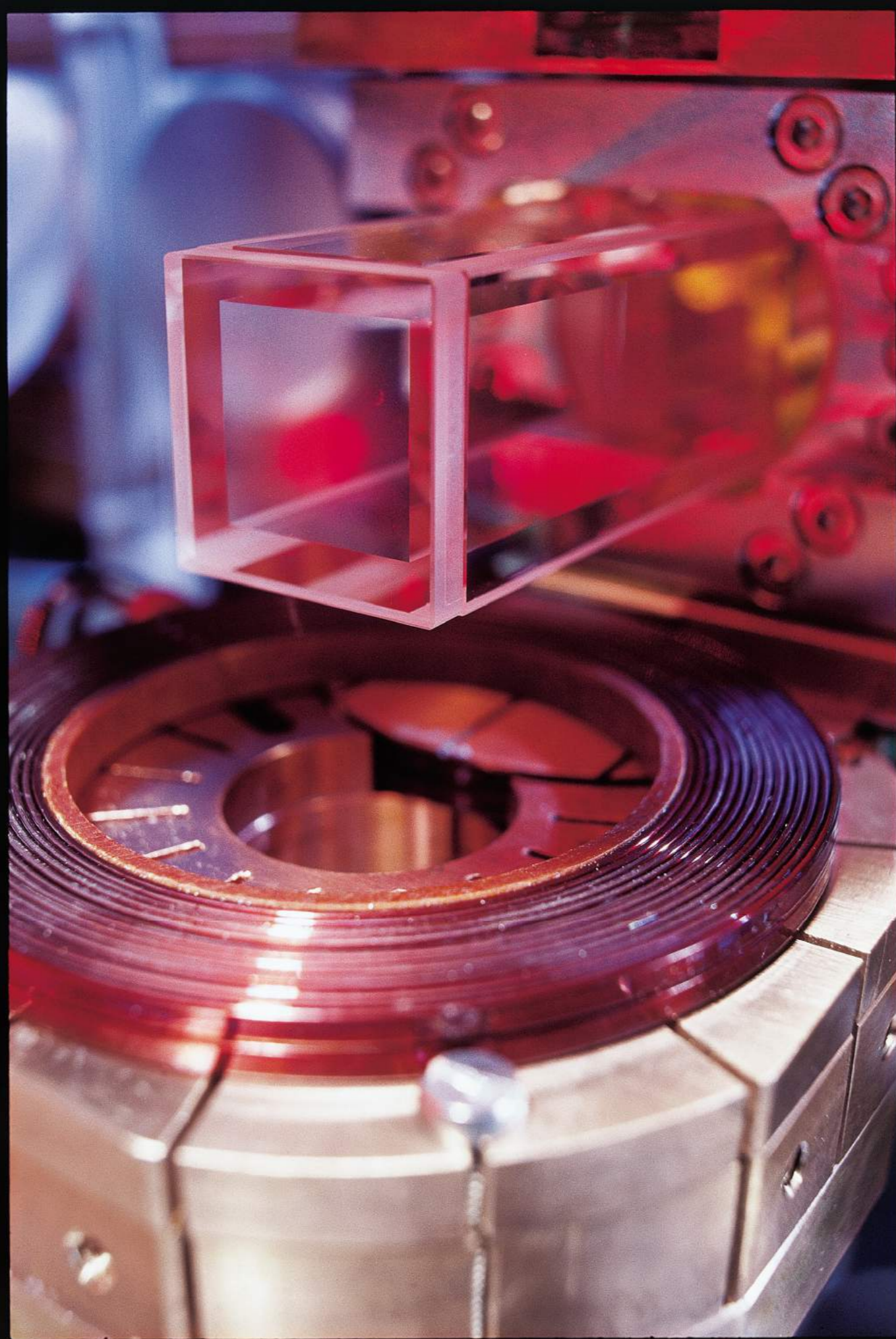



x10000

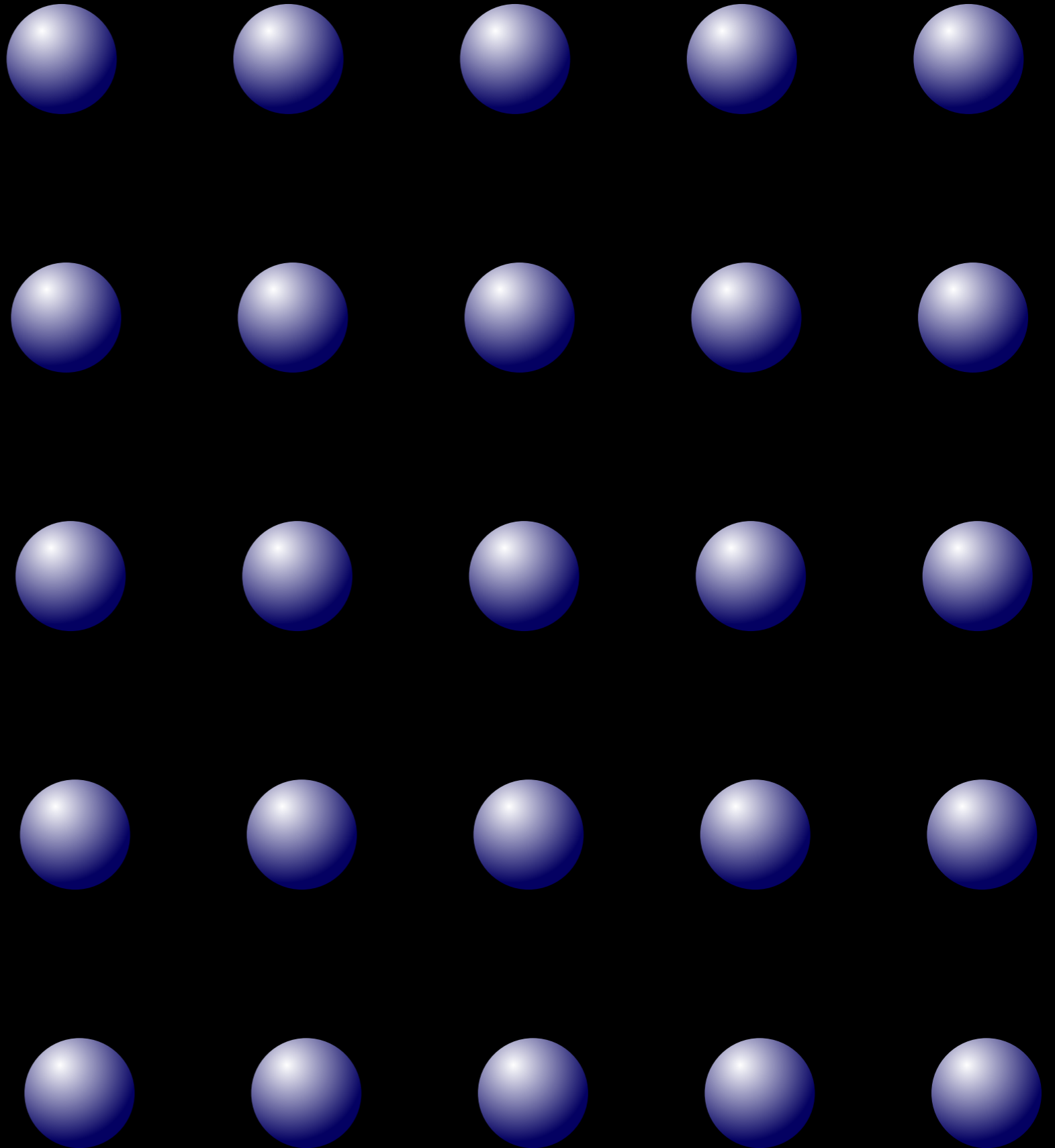

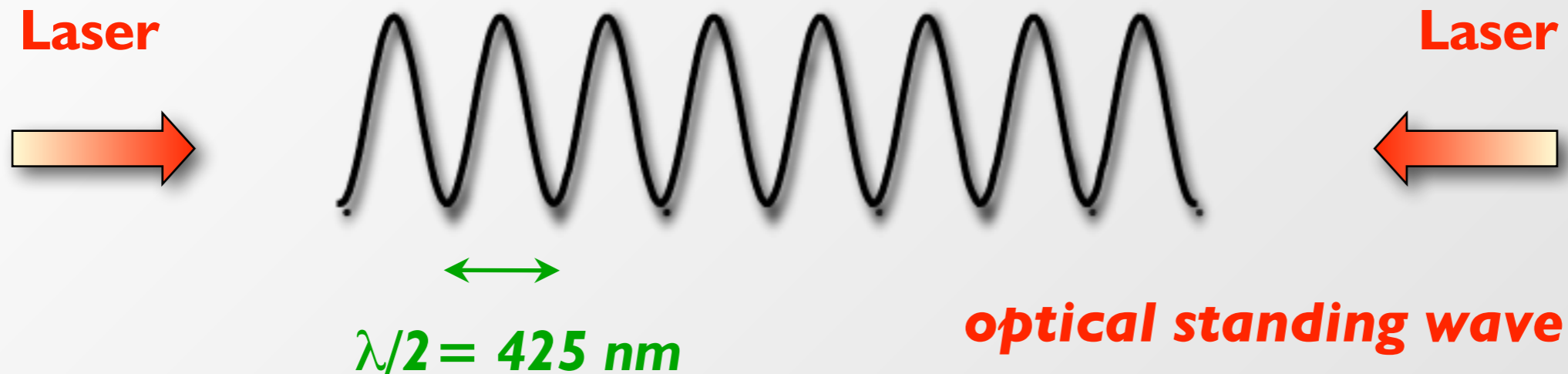

*Perfect model systems for a
fundamental understanding of
quantum many-body systems*



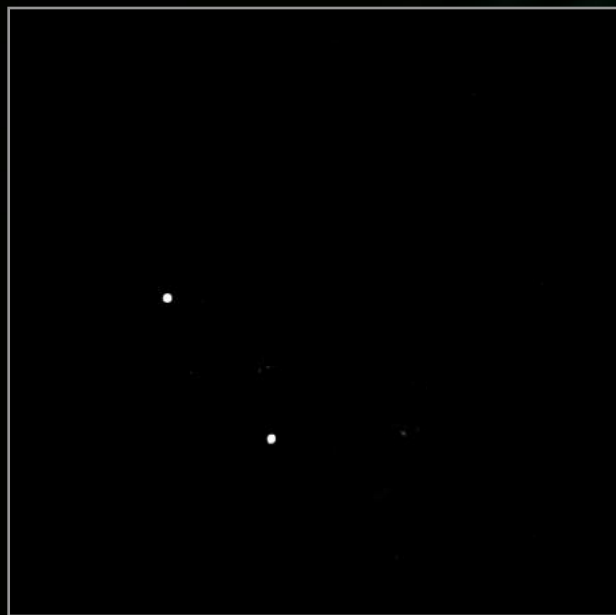

courtesy: T.W. Hänsch

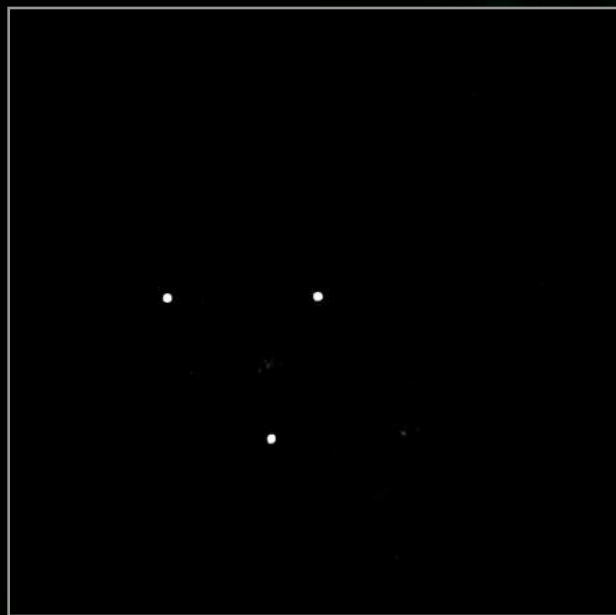
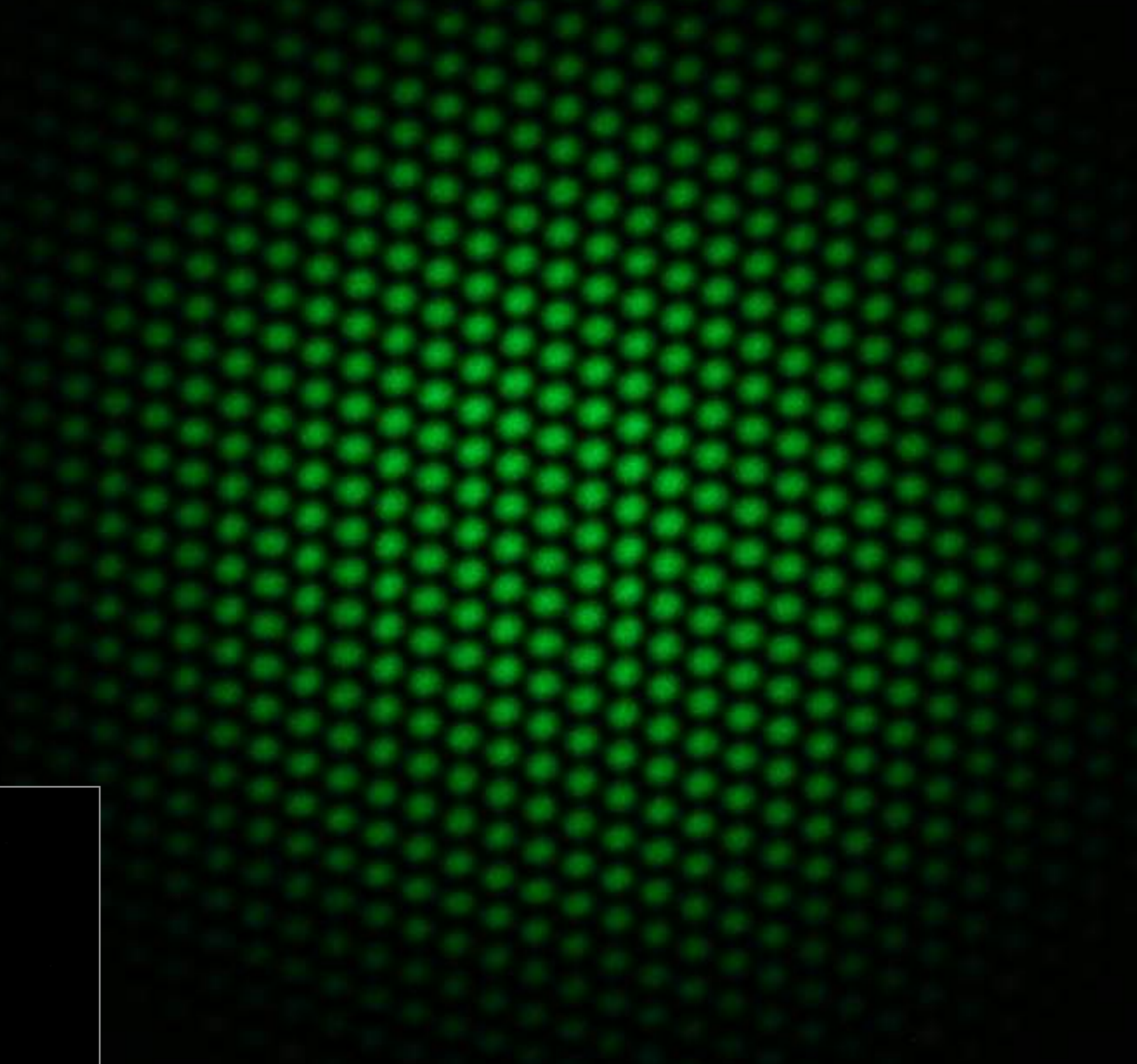

courtesy: T.W. Hänsch

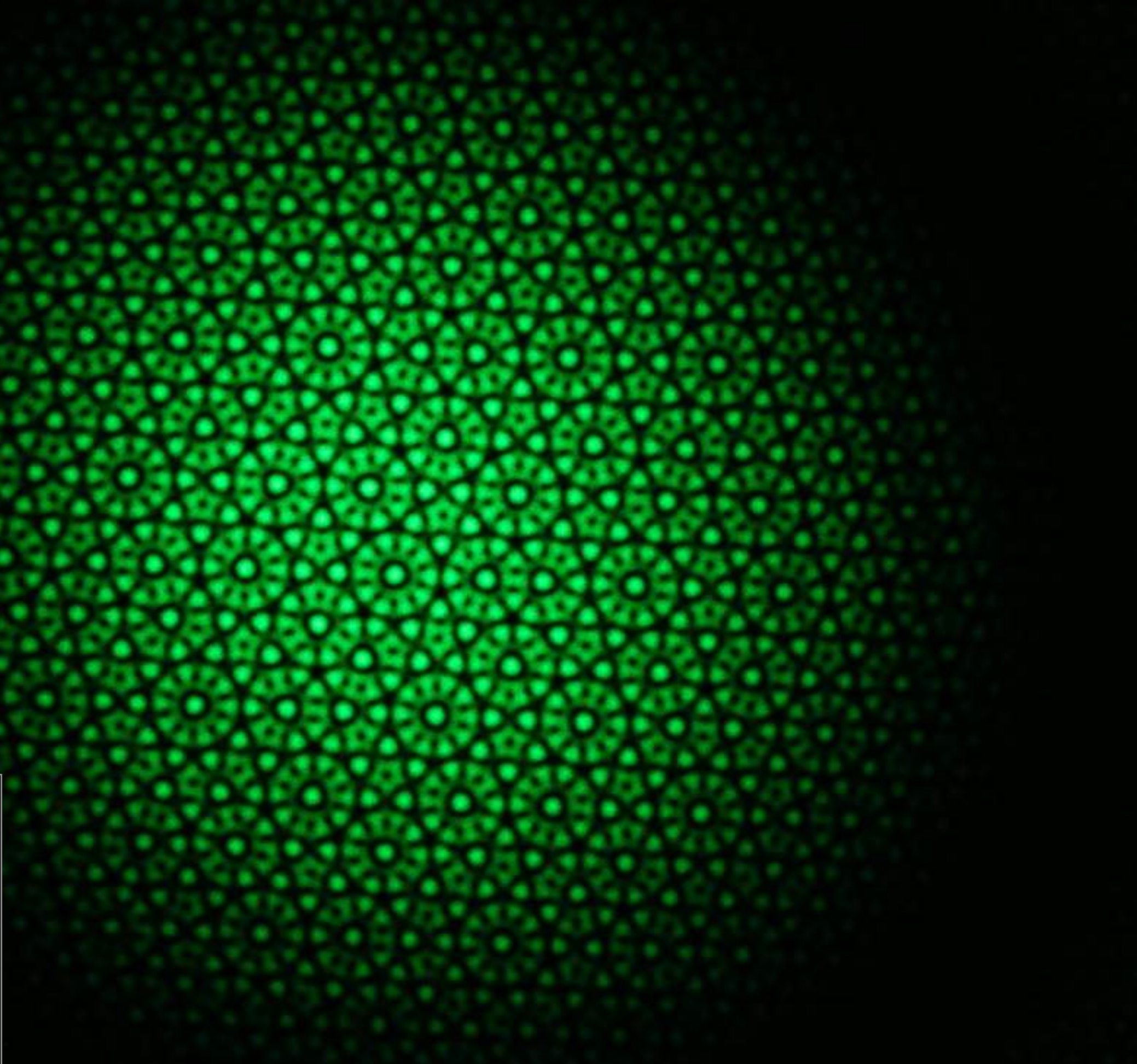
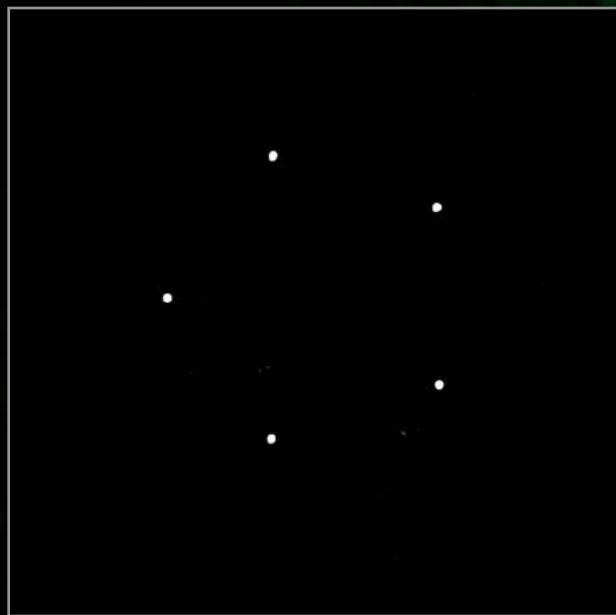

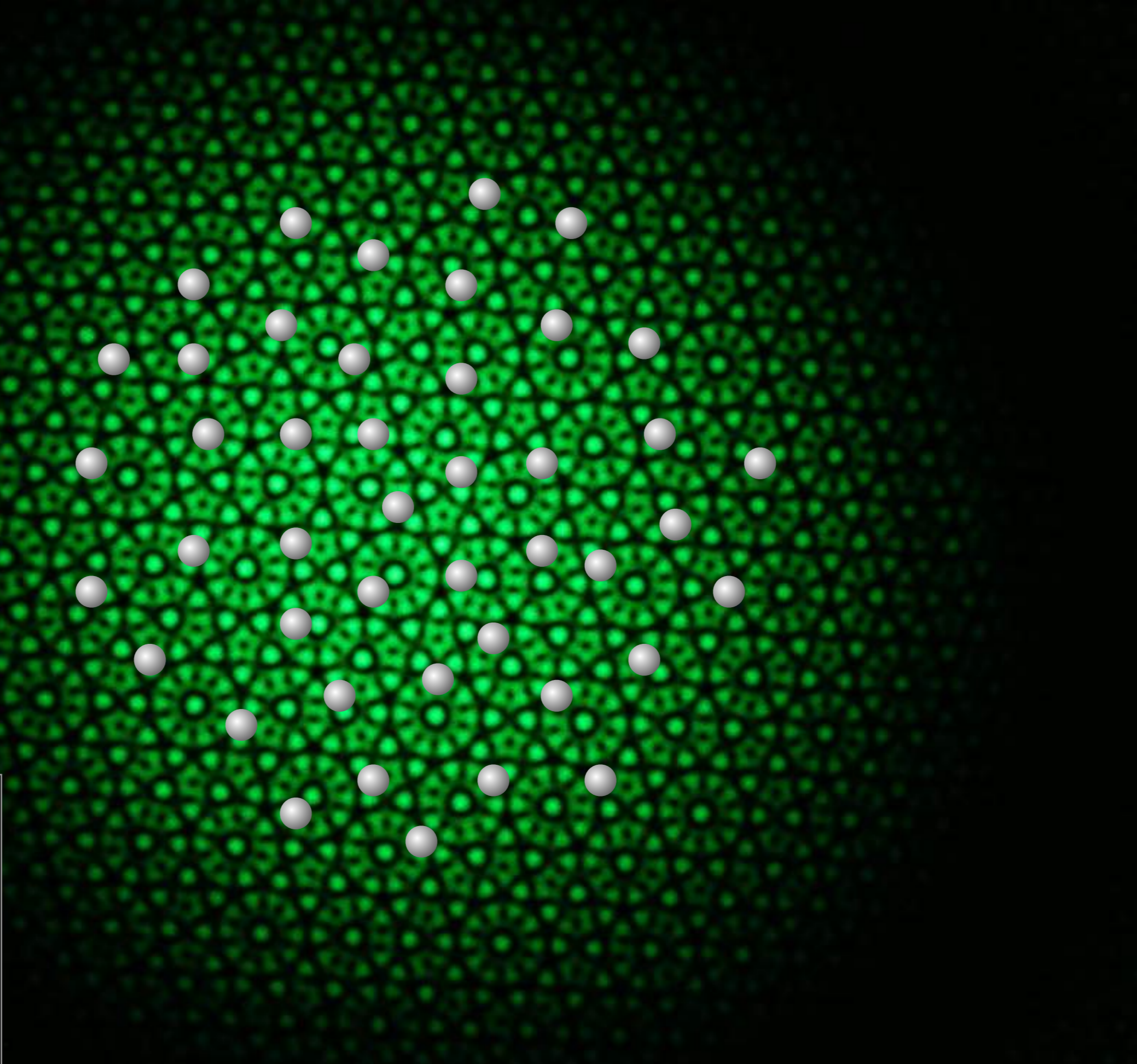
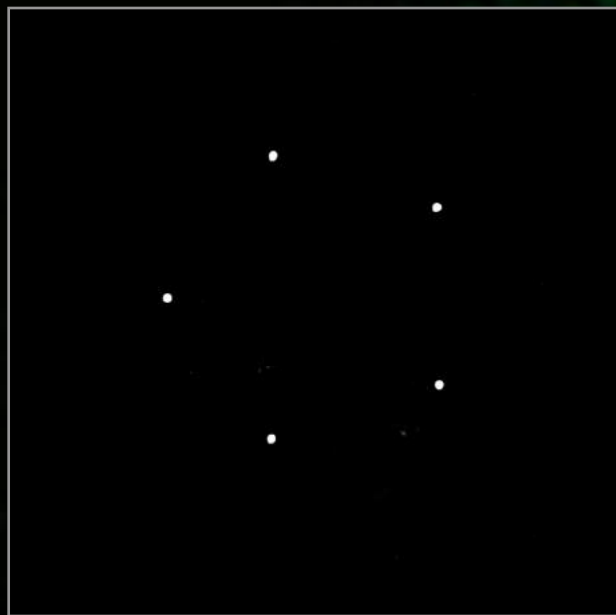

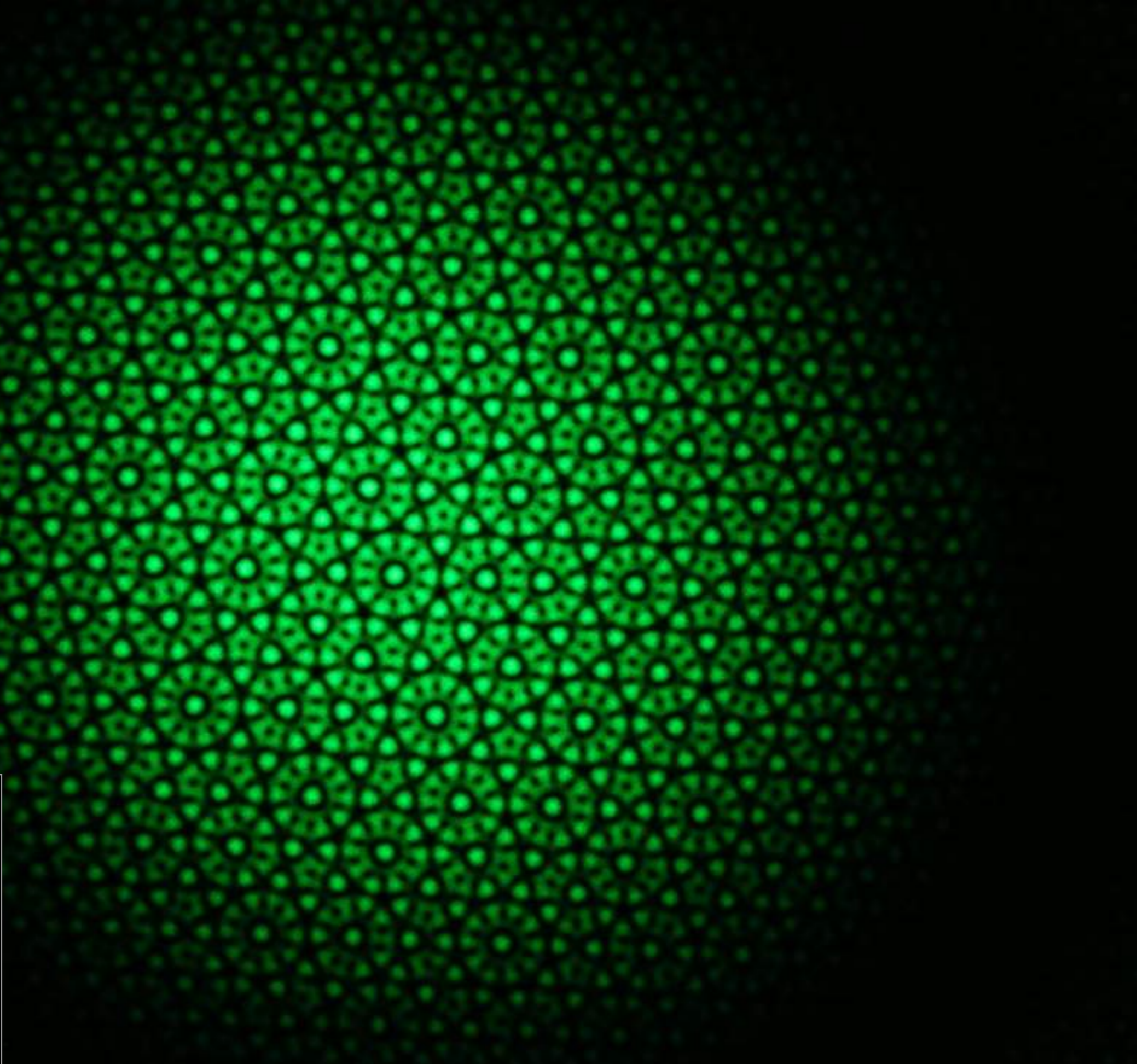
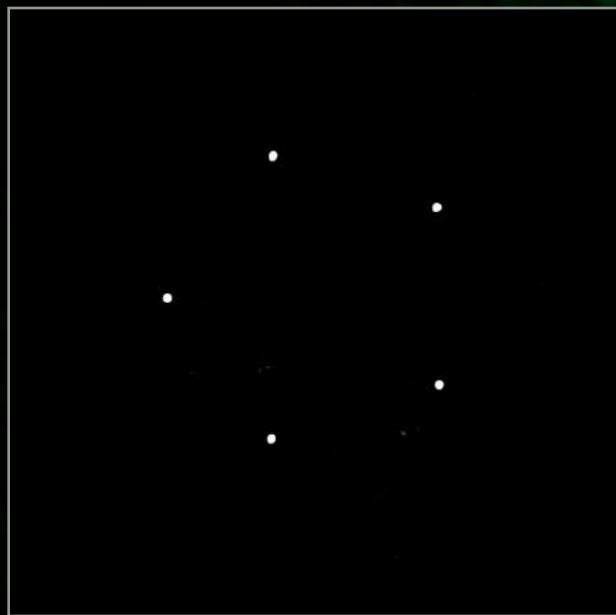

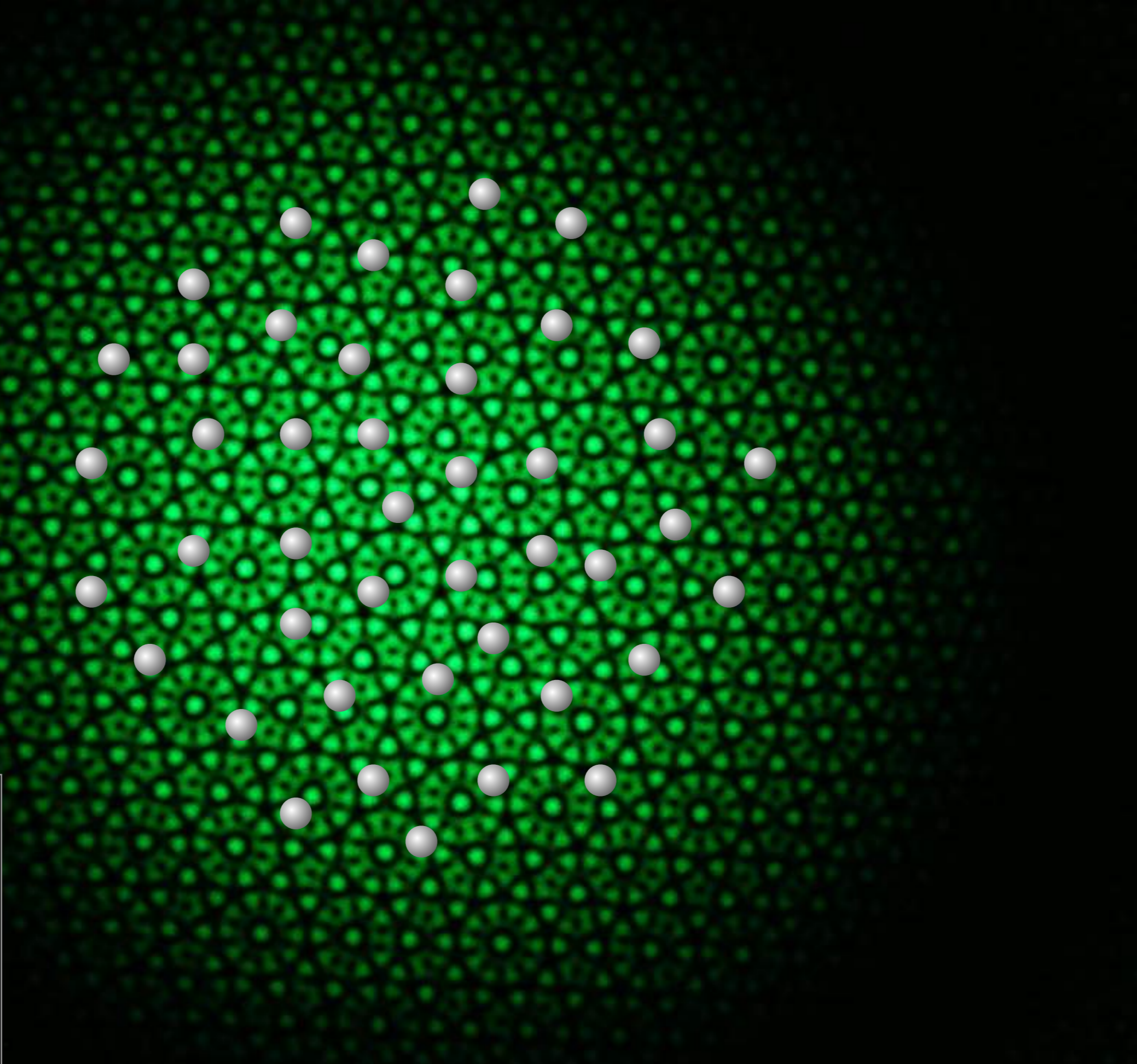
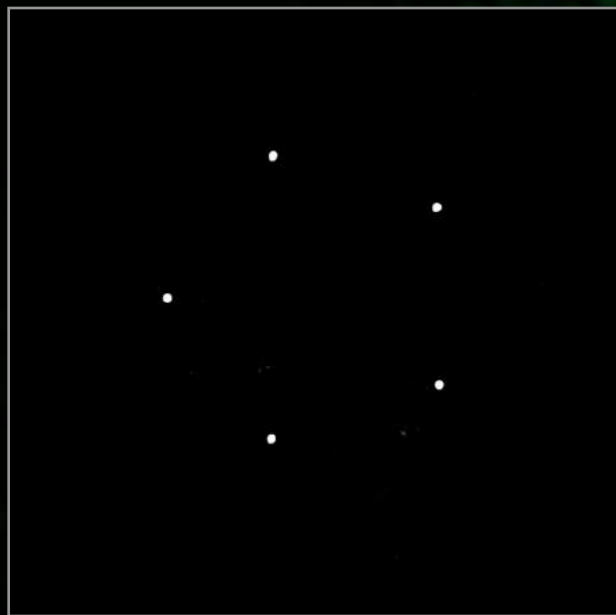

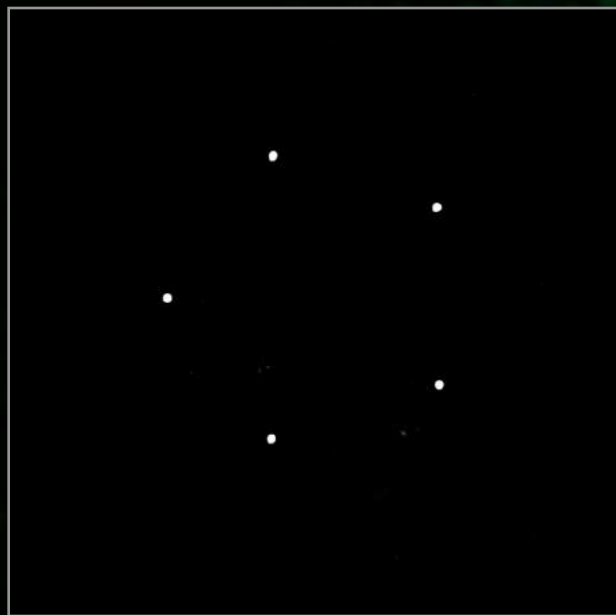
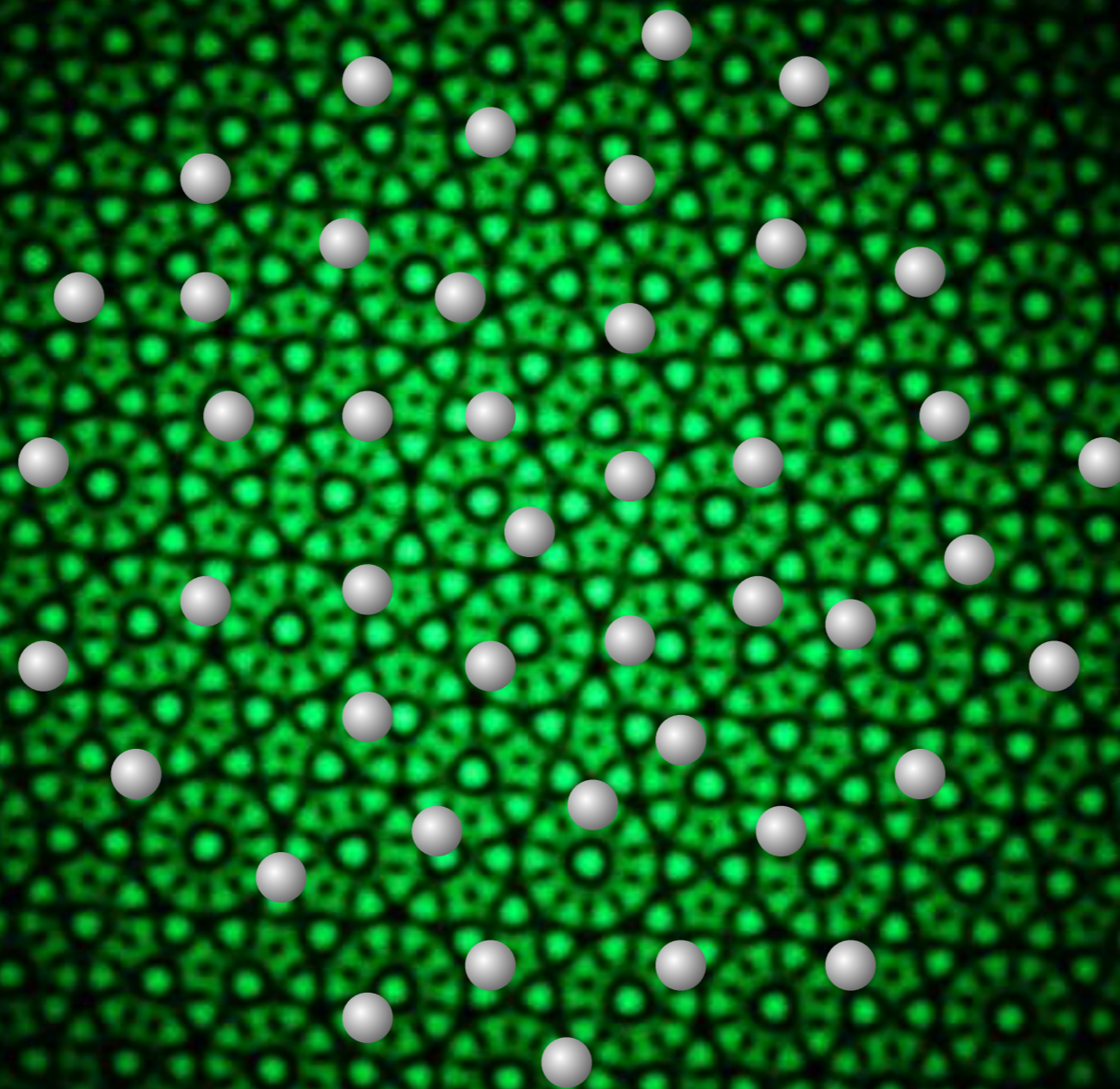

Few particles up to 1000s
of particles !

Quantum Spin Systems

Particle Systems: Bosons, Fermions, Mixtures

Classically Intractable Computational Regimes

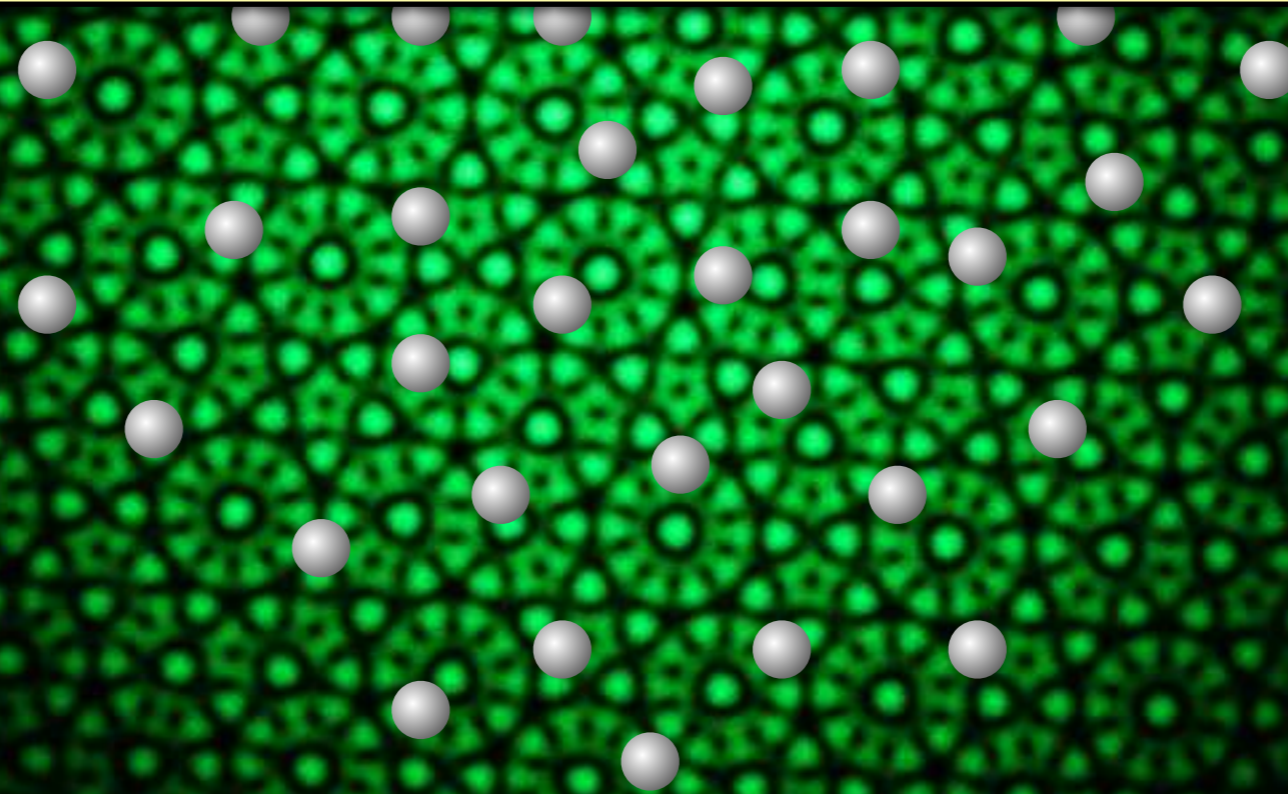

Few particles up to 1000s
of particles !

Optical Lattices

Optical Lattices

From Artificial Quantum Matter to Real Materials

Quantum Regime

$$\lambda/d \gtrsim 1$$

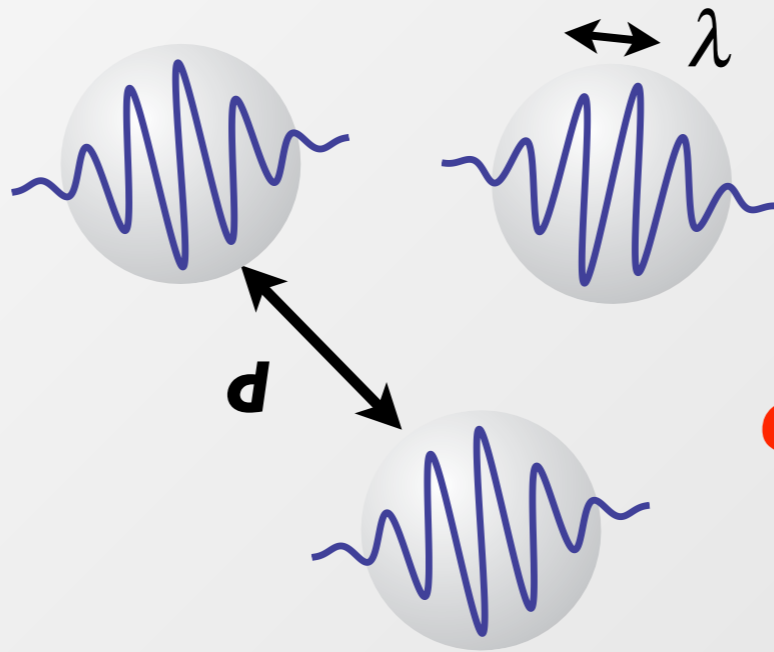

de Broglie Wavepackets

**Universality of
Quantum Mechanics!**

From Artificial Quantum Matter to Real Materials

Quantum Regime

$$\lambda/d \gtrsim 1$$

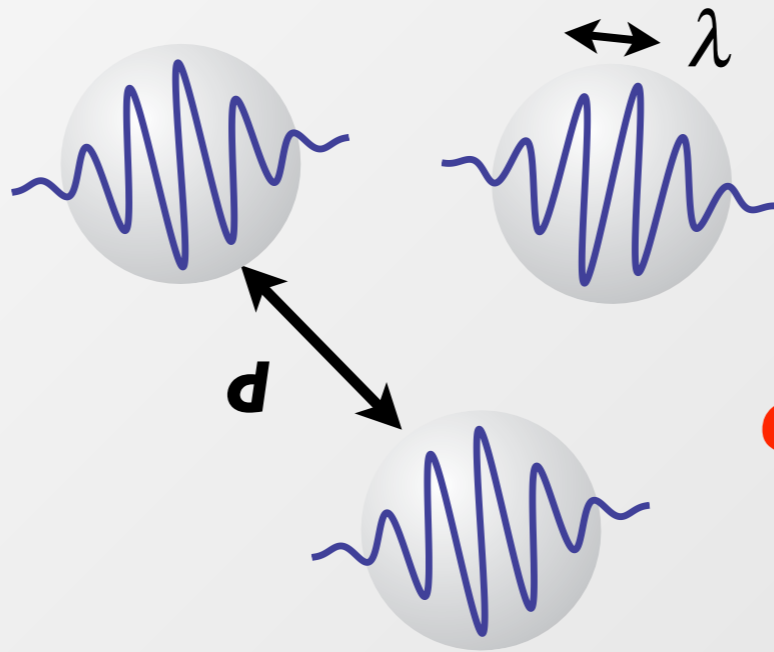

de Broglie Wavepackets

**Universality of
Quantum Mechanics!**

Ultracold Quantum Matter

- **Densities:** $10^{14}/\text{cm}^3$
(100000 times thinner than air)
- **Temperatures:** **few nK**
(100 million times lower than outer space)

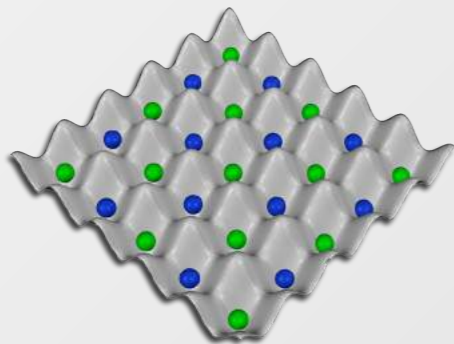

Real Materials

- **Densities:** $10^{24}-10^{25}/\text{cm}^3$
- **Temperatures:** **mK – several hundred K**

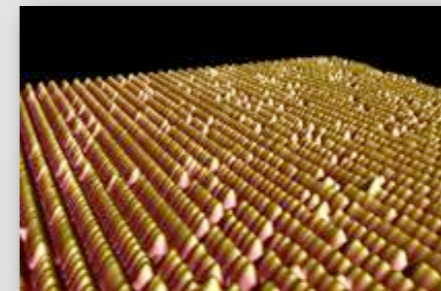

(Neuchatel)

Same λ/d !

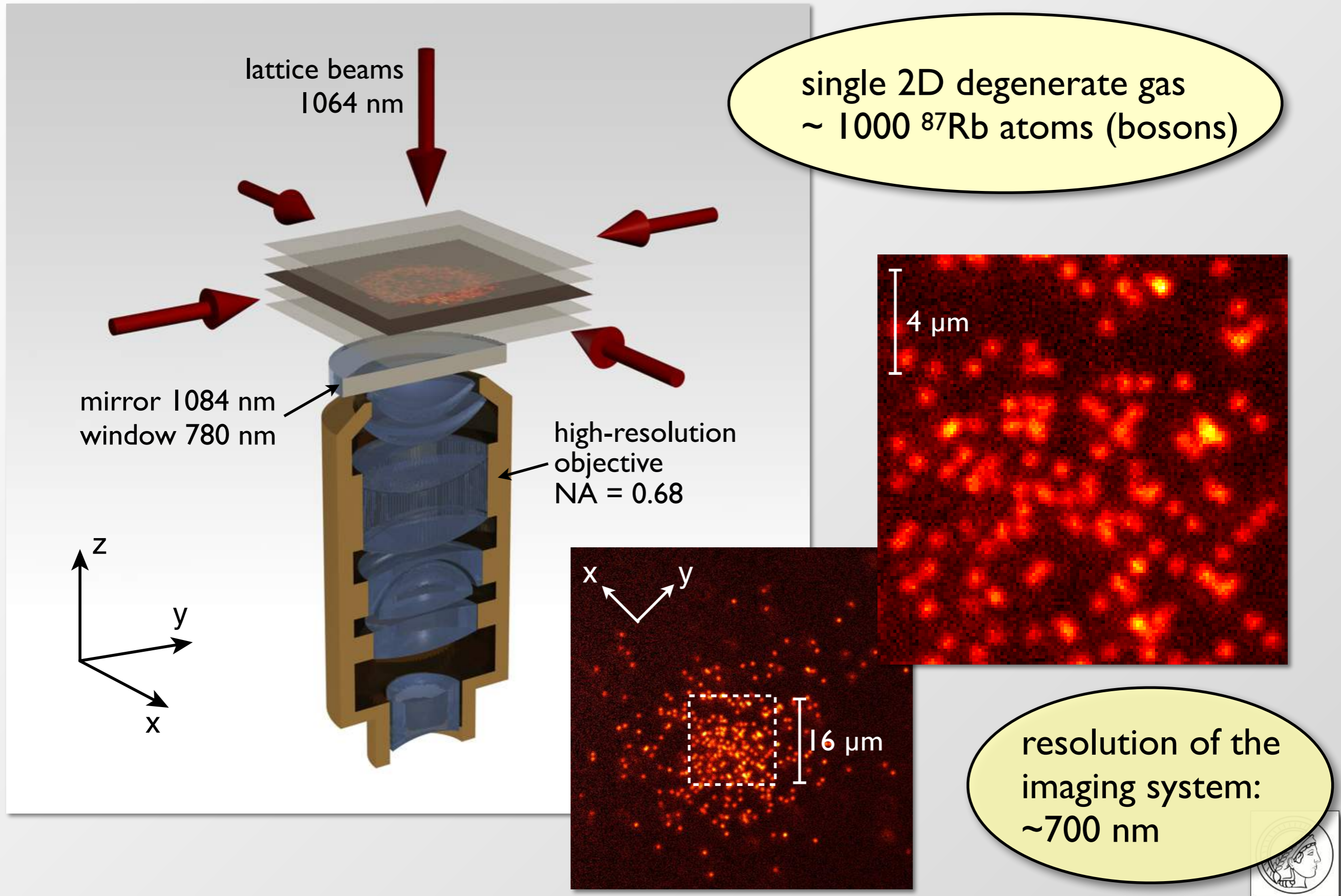

Snapshot of an Atomic Density Distribution

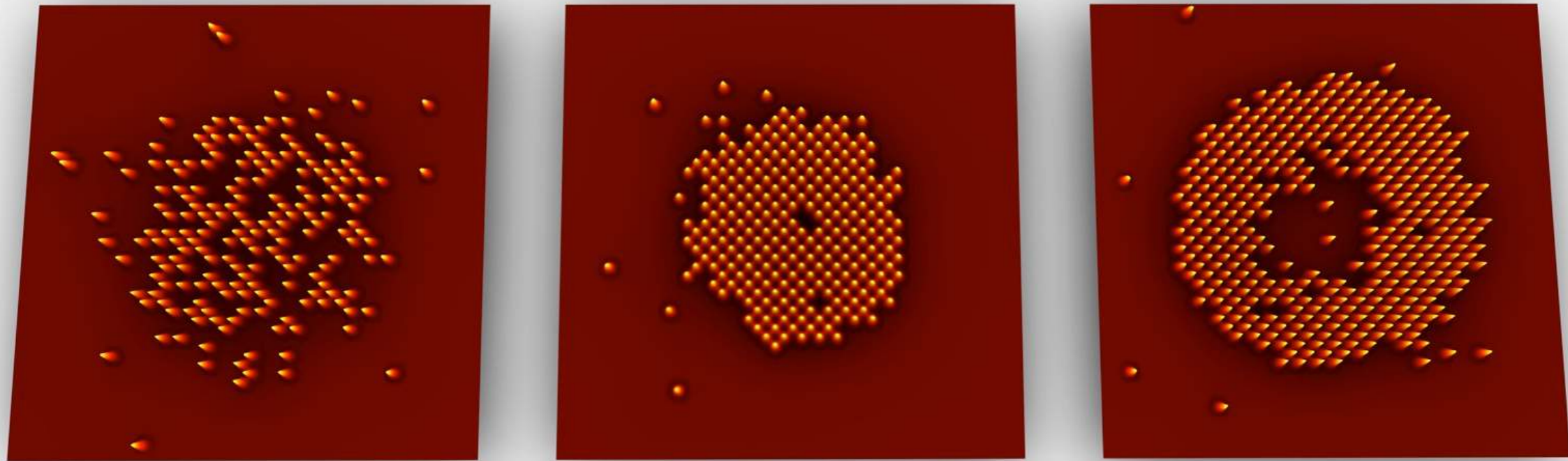

BEC

$n=1$
Mott Insulator

$n=1$ & $n=2$
Mott Insulator

M. Greiner *et al.* Nature 415, 39 (2002),

J. Sherson *et al.* Nature **467**, 68 (2010), W. Bakr *et al.* Science **329**, 547 (2010)

Cold atom prediction: D. Jaksch *et al.* **81**, 3108 (1998)



Snapshot of an Atomic Density Distribution

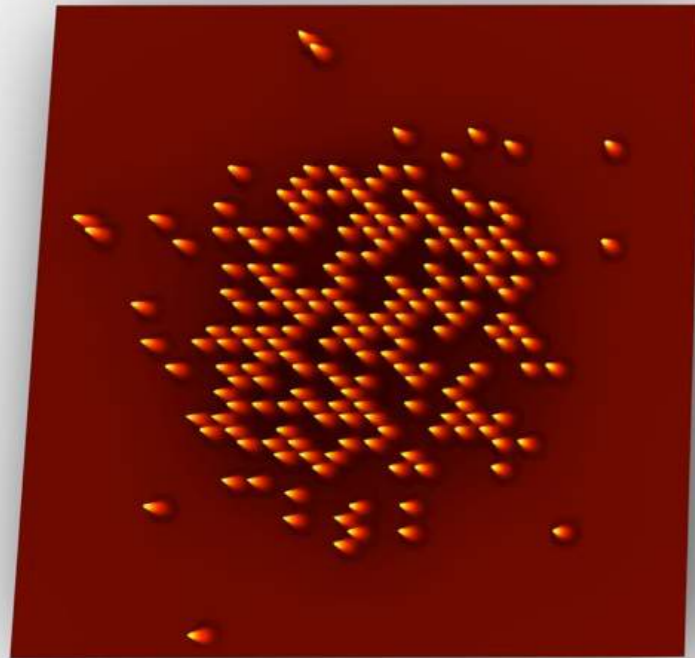

BEC

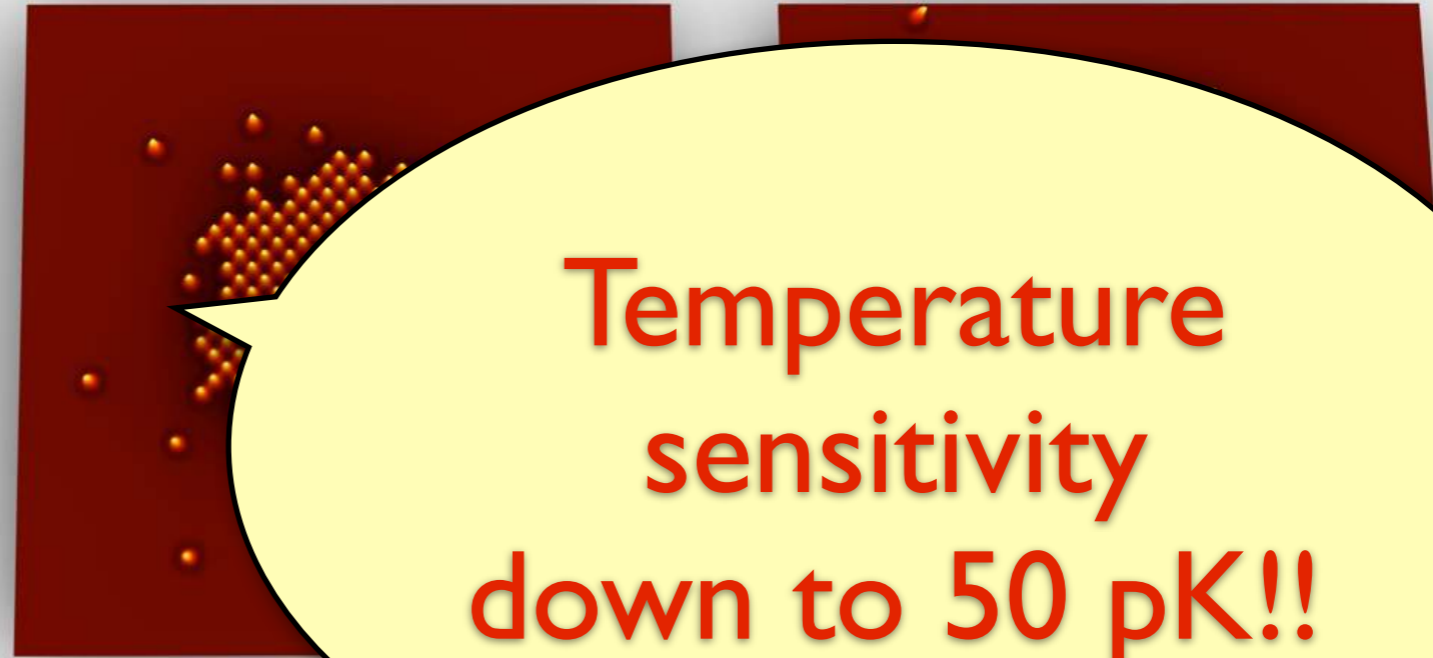

Temperature
sensitivity
down to 50 pK!!

$n=1$
Mott Insulator

$n=1$ & $n=2$
Mott Insulator

M. Greiner *et al.* Nature 415, 39 (2002),

J. Sherson *et al.* Nature **467**, 68 (2010), W. Bakr *et al.* Science **329**, 547 (2010)

Cold atom prediction: D. Jaksch *et al.* **81**, 3108 (1998)



Single Site Addressing

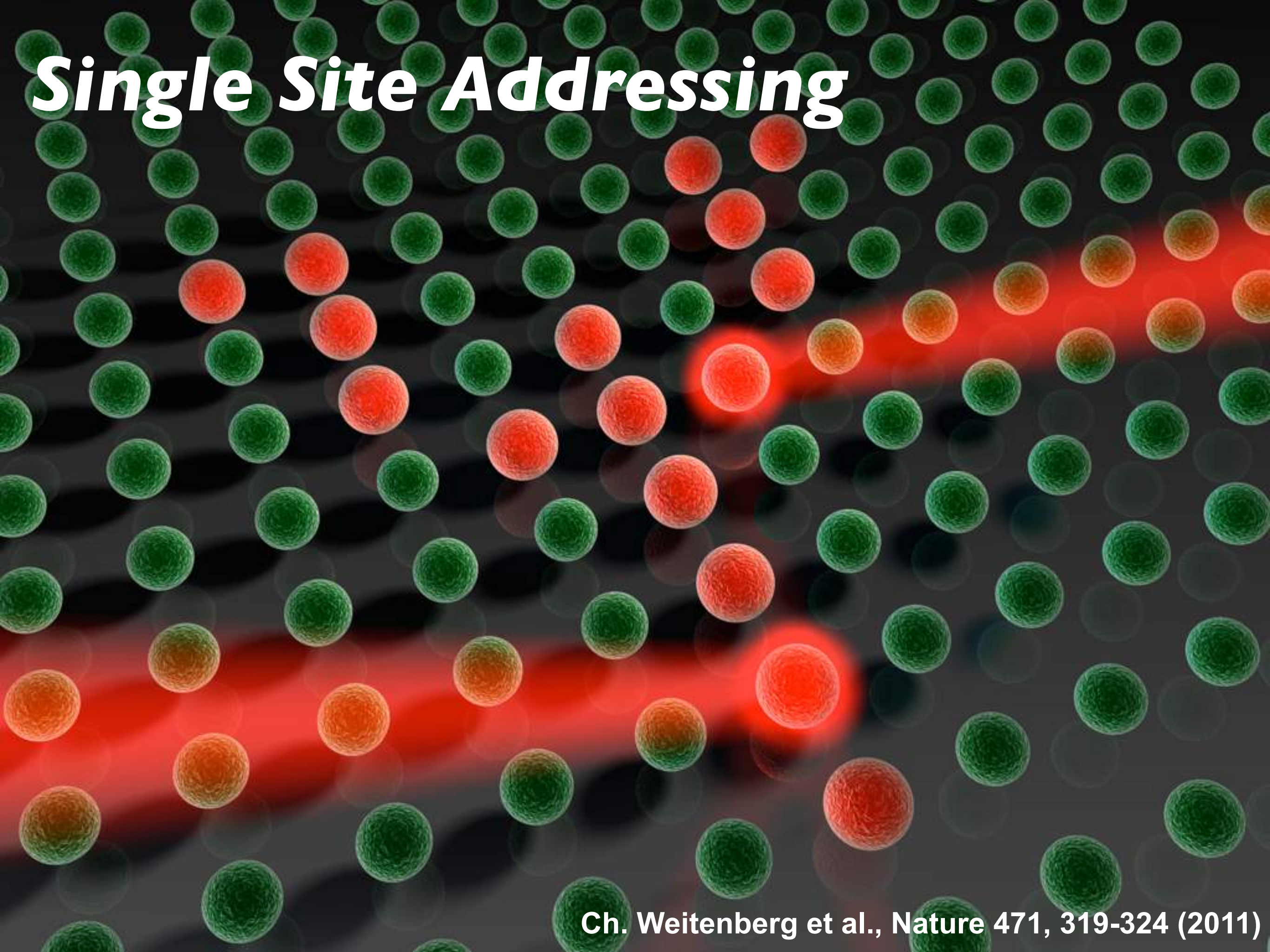

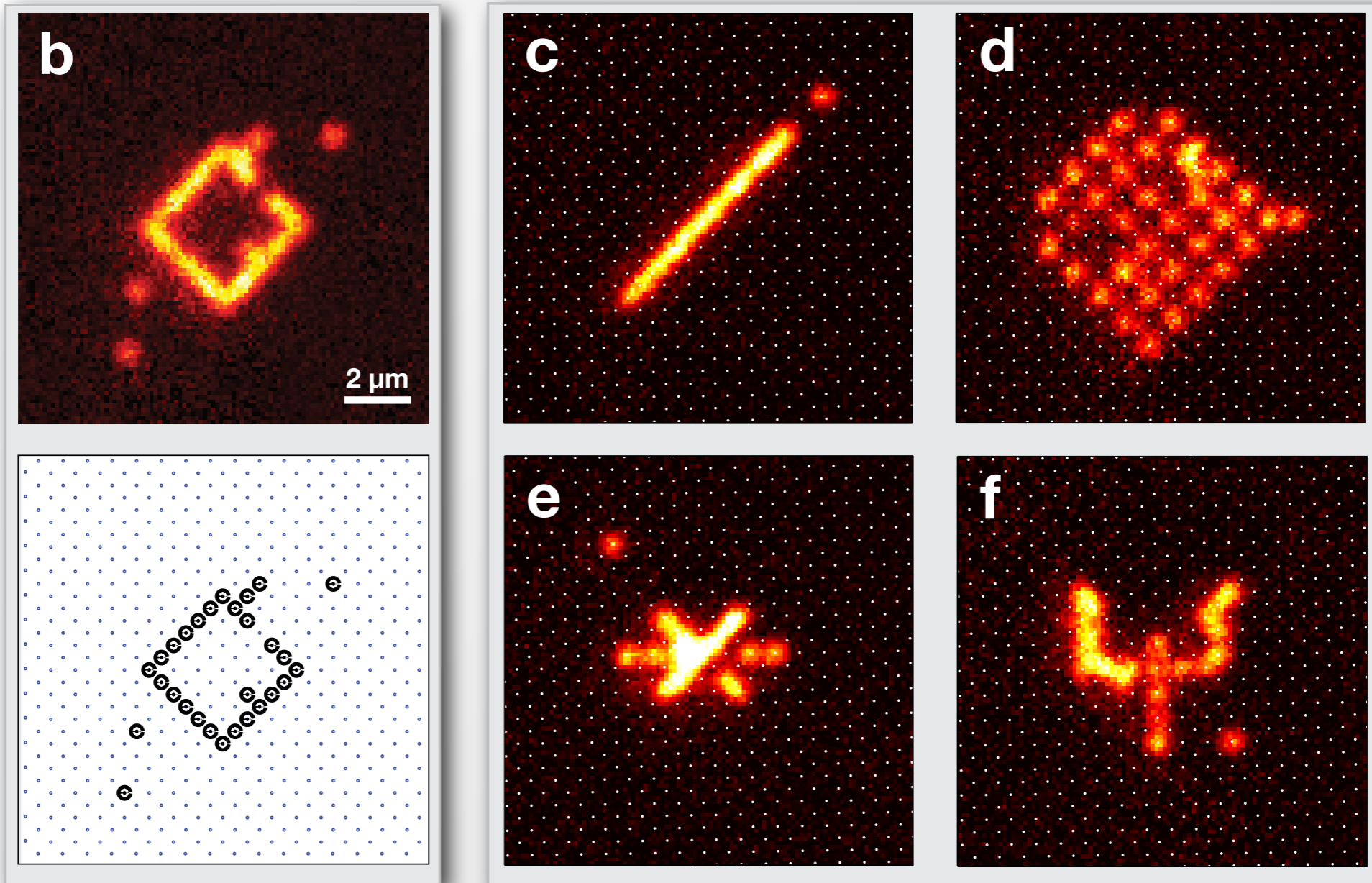

Subwavelength spatial resolution: 50 nm



Single Atom Tunneling

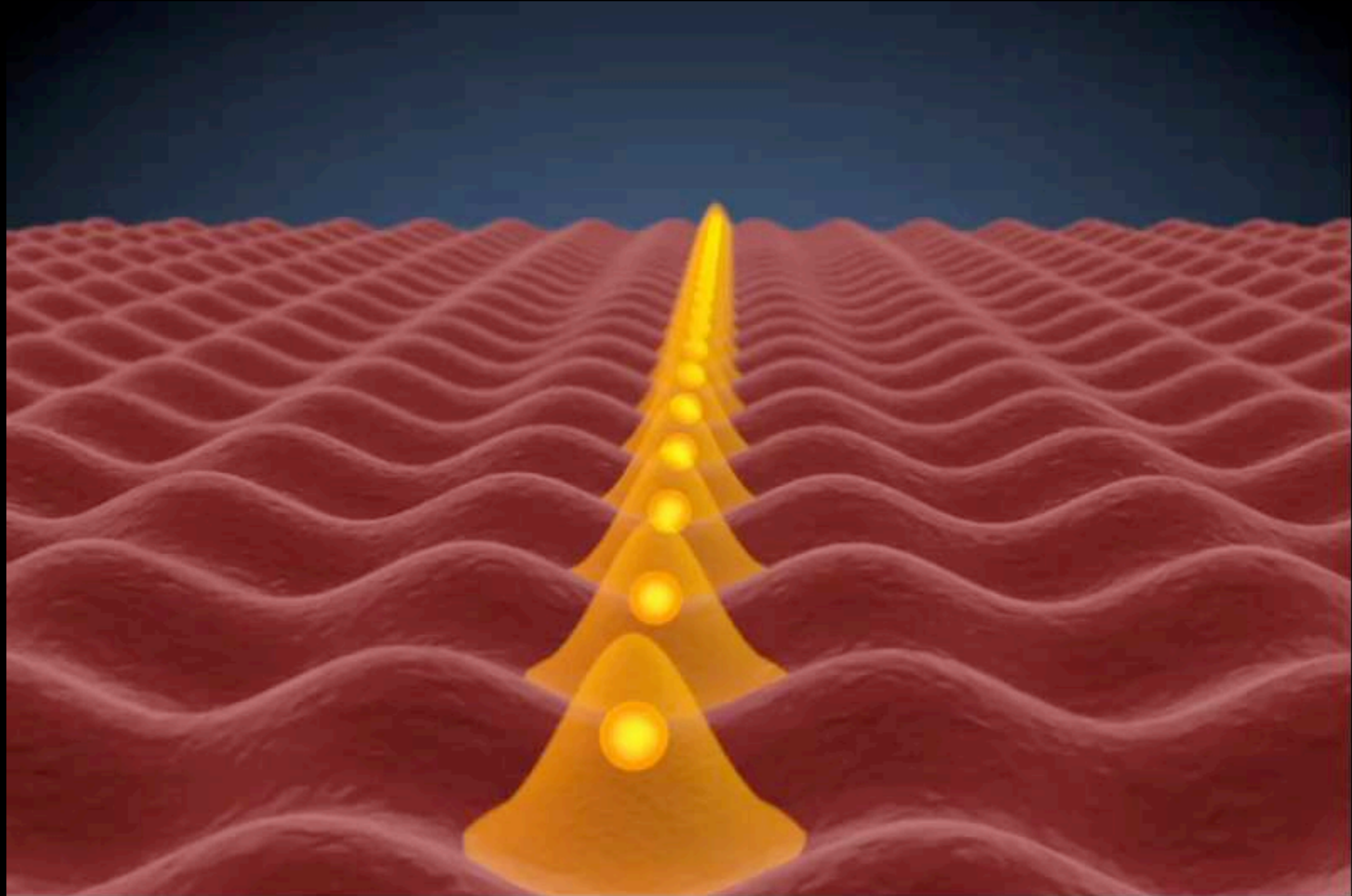

Single Atom Tunneling

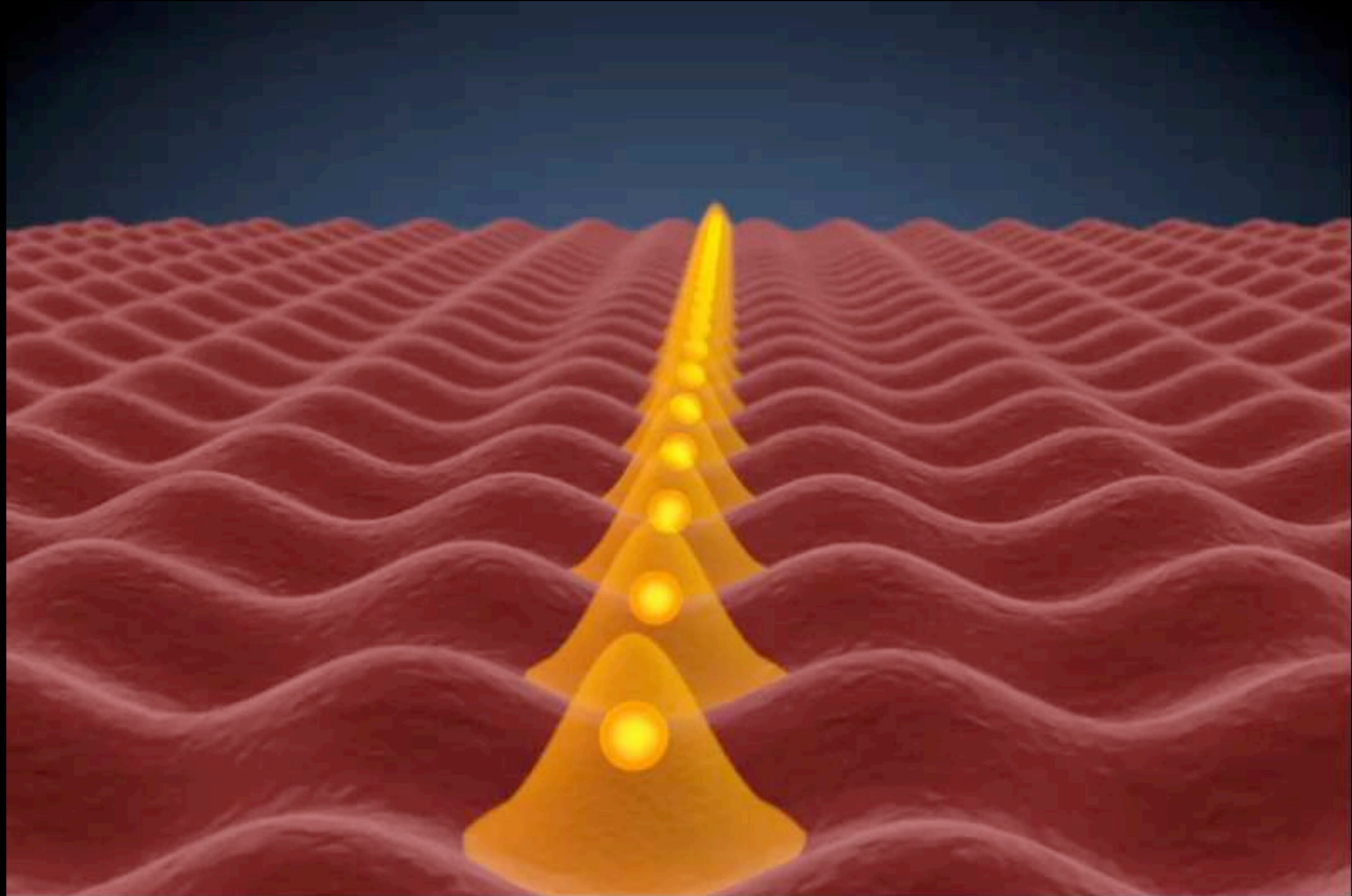

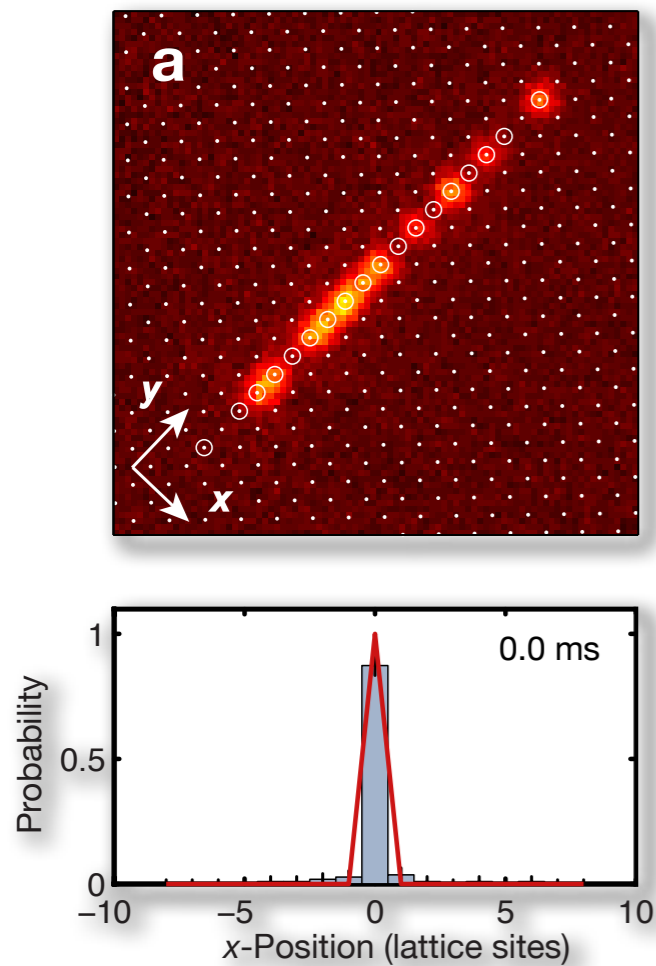

see exp: Y. Silberberg (photonic waveguides), D. Meschede & R. Blatt (quantum walks)...



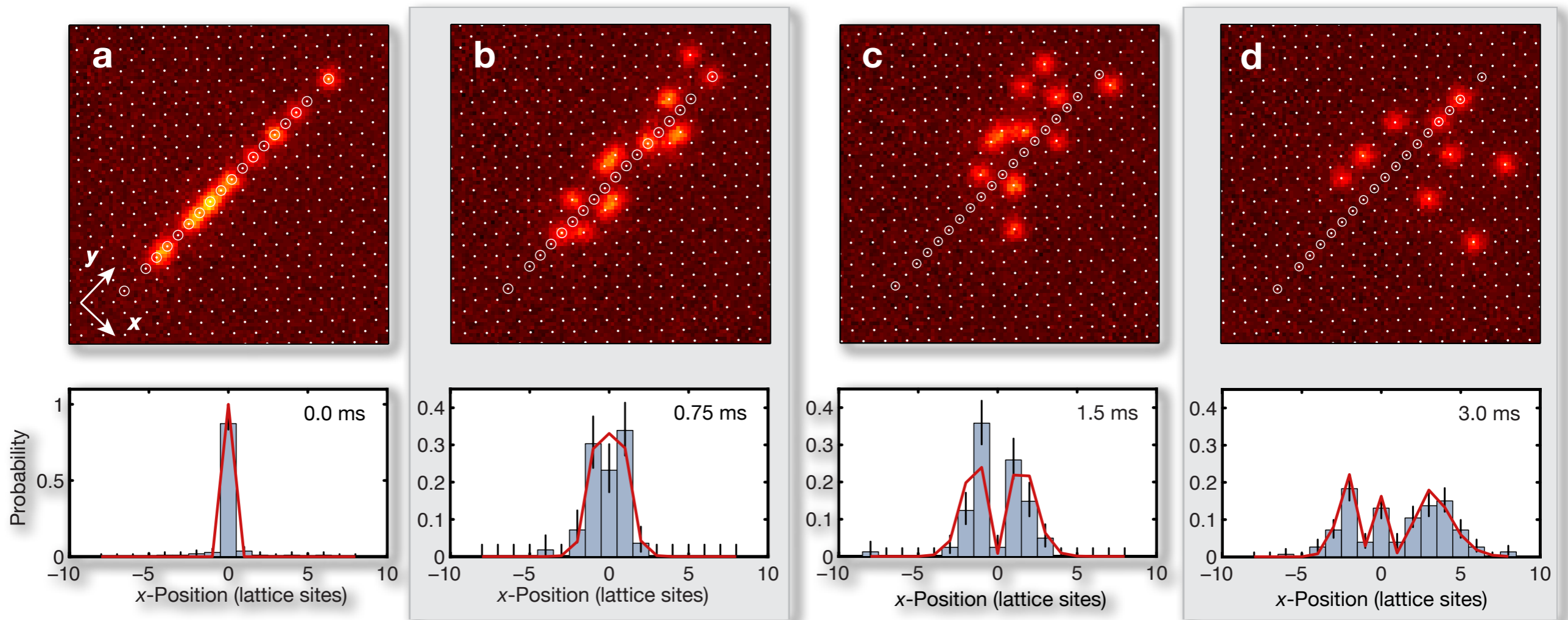

see exp: Y. Silberberg (photonic waveguides), D. Meschede & R. Blatt (quantum walks)...



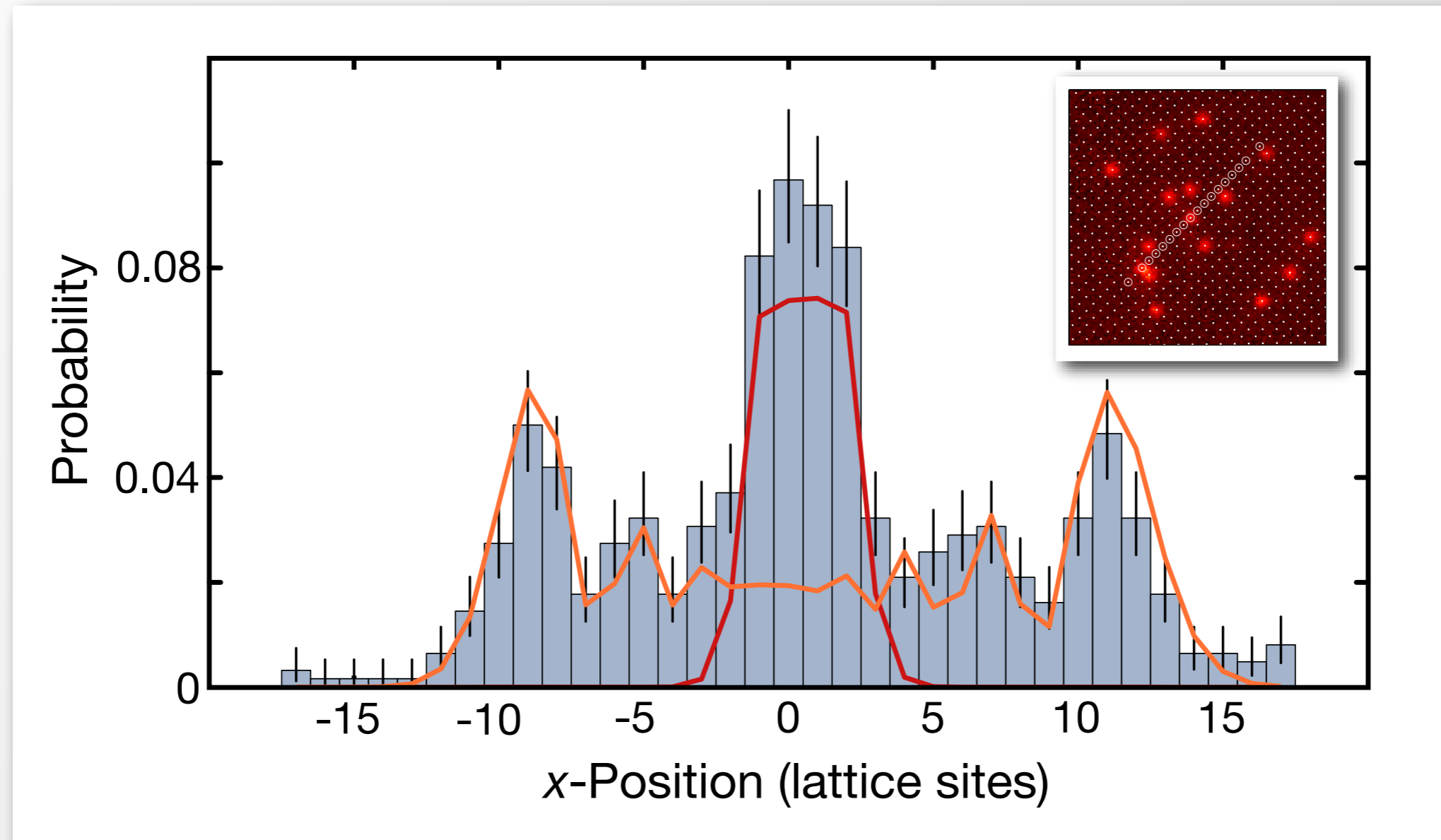

Excellent agreement with simulation.

Interesting extension: Quantum walks of correlated atoms/spins...



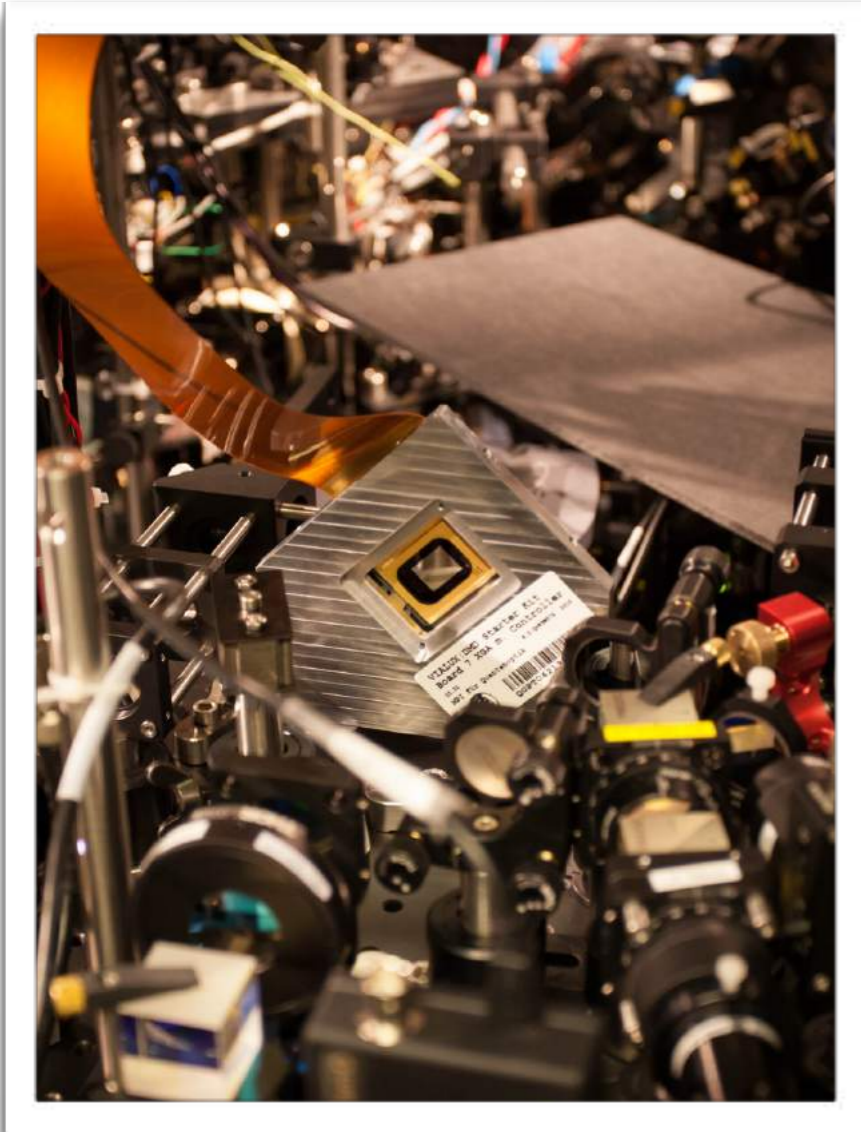

Digital Mirror Device
(DMD)



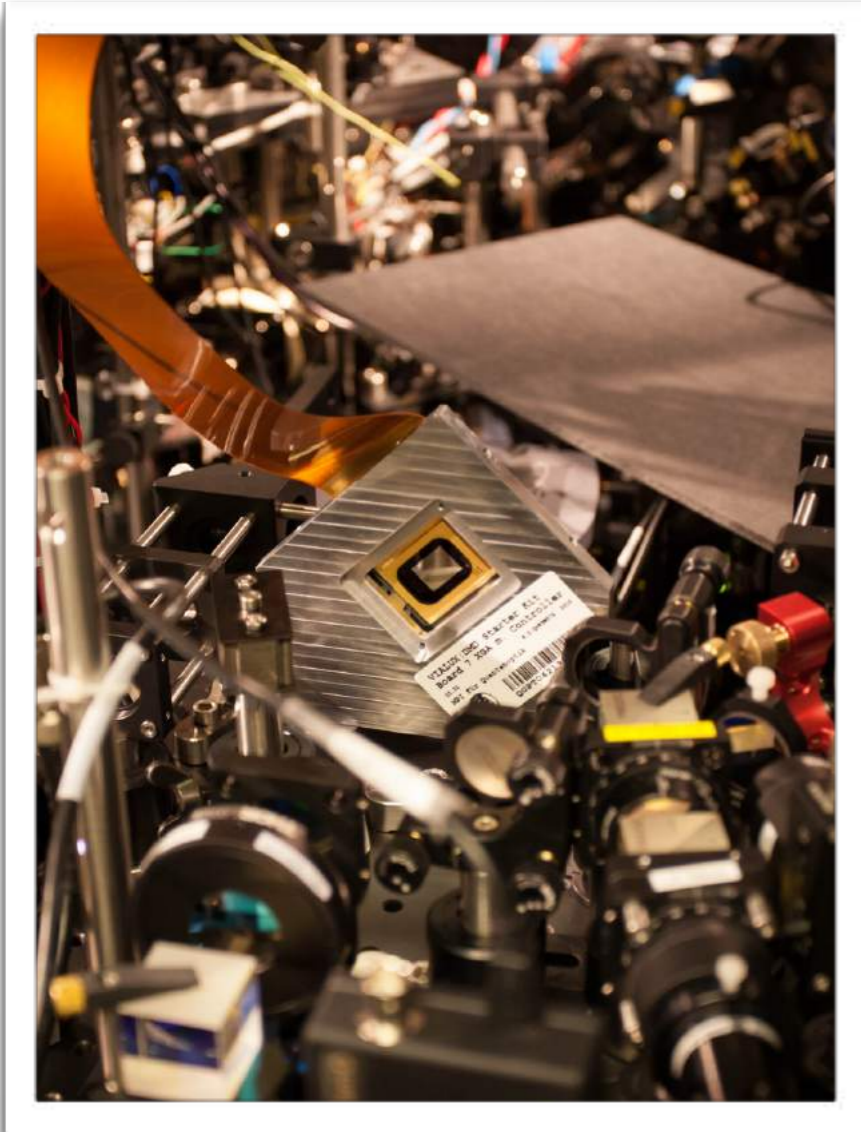

Digital Mirror Device
(DMD)

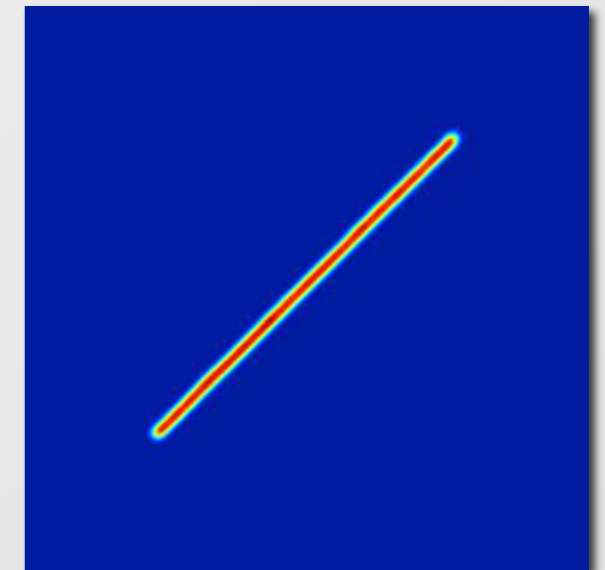
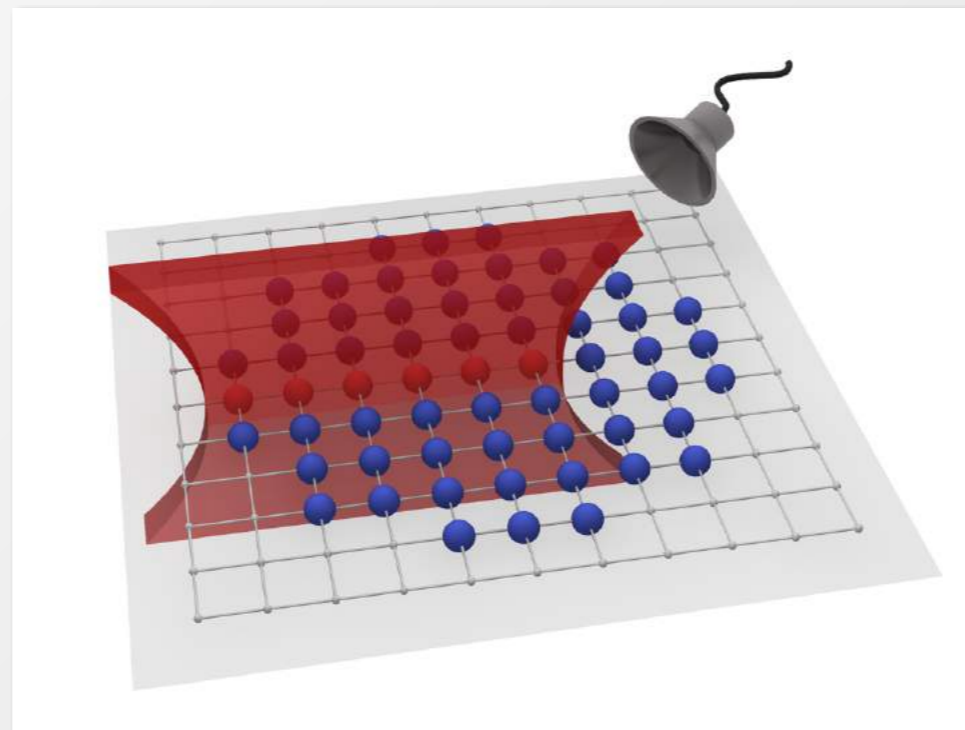

Measured Light Pattern



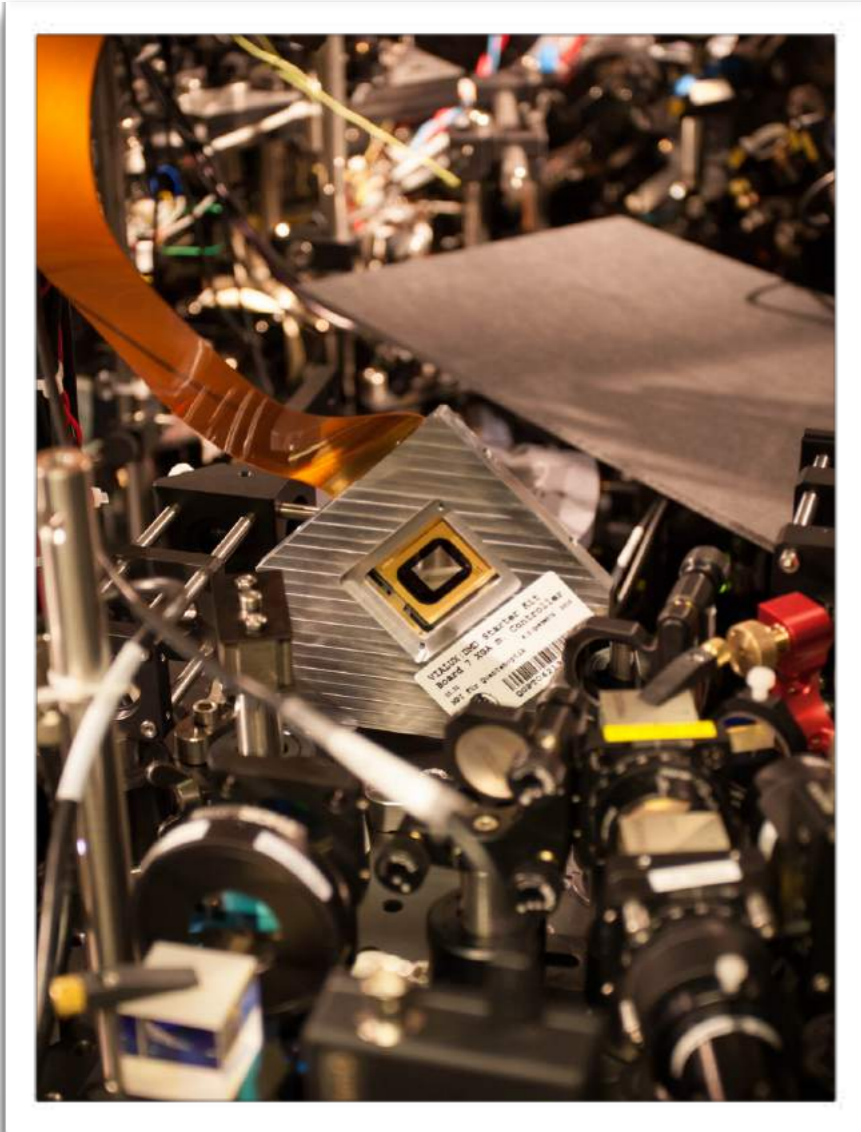

Digital Mirror Device (DMD)

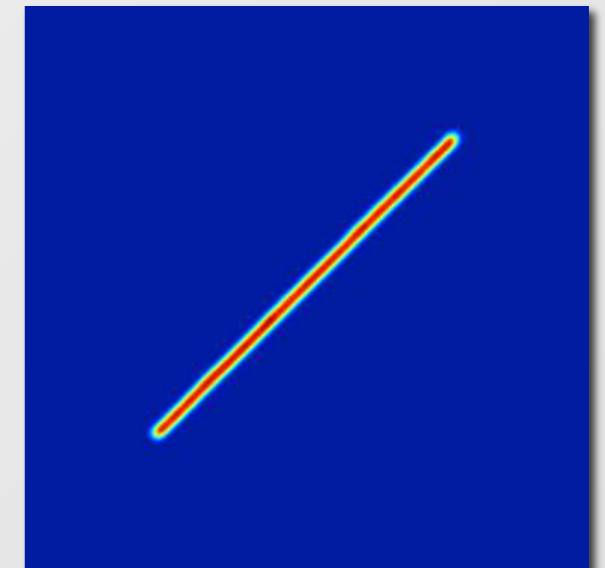
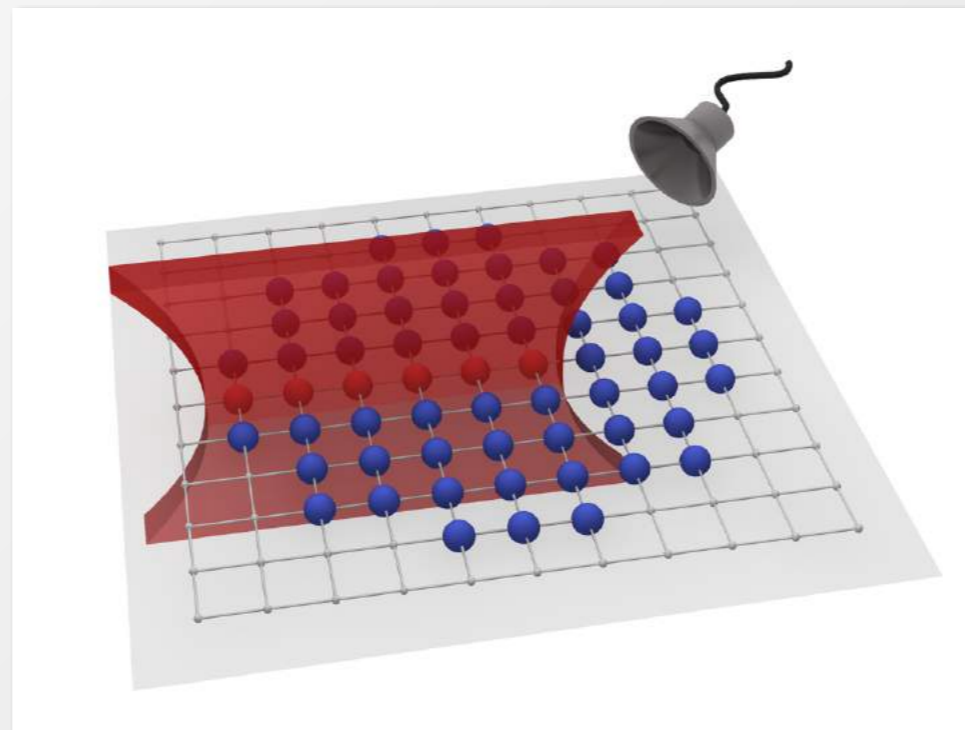

Measured Light Pattern

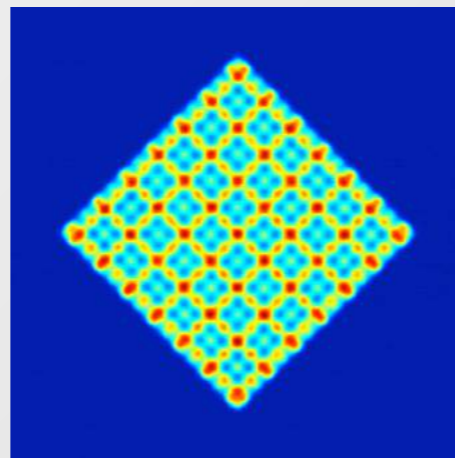

Exotic Lattices

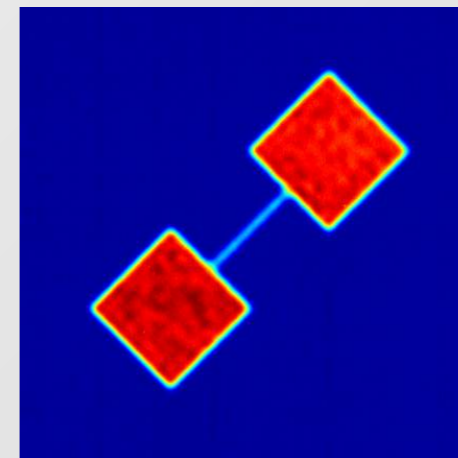

Quantum Wires

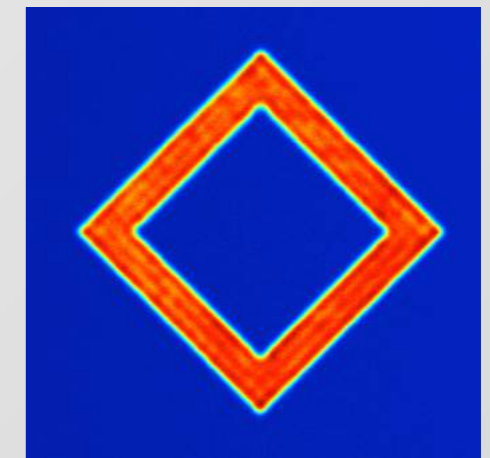

Box Potentials

Almost Arbitrary Light Patterns Possible!

Single Spin Impurity Dynamics, Domain Walls, Quantum Wires, Novel Exotic Lattice Geometries, ...



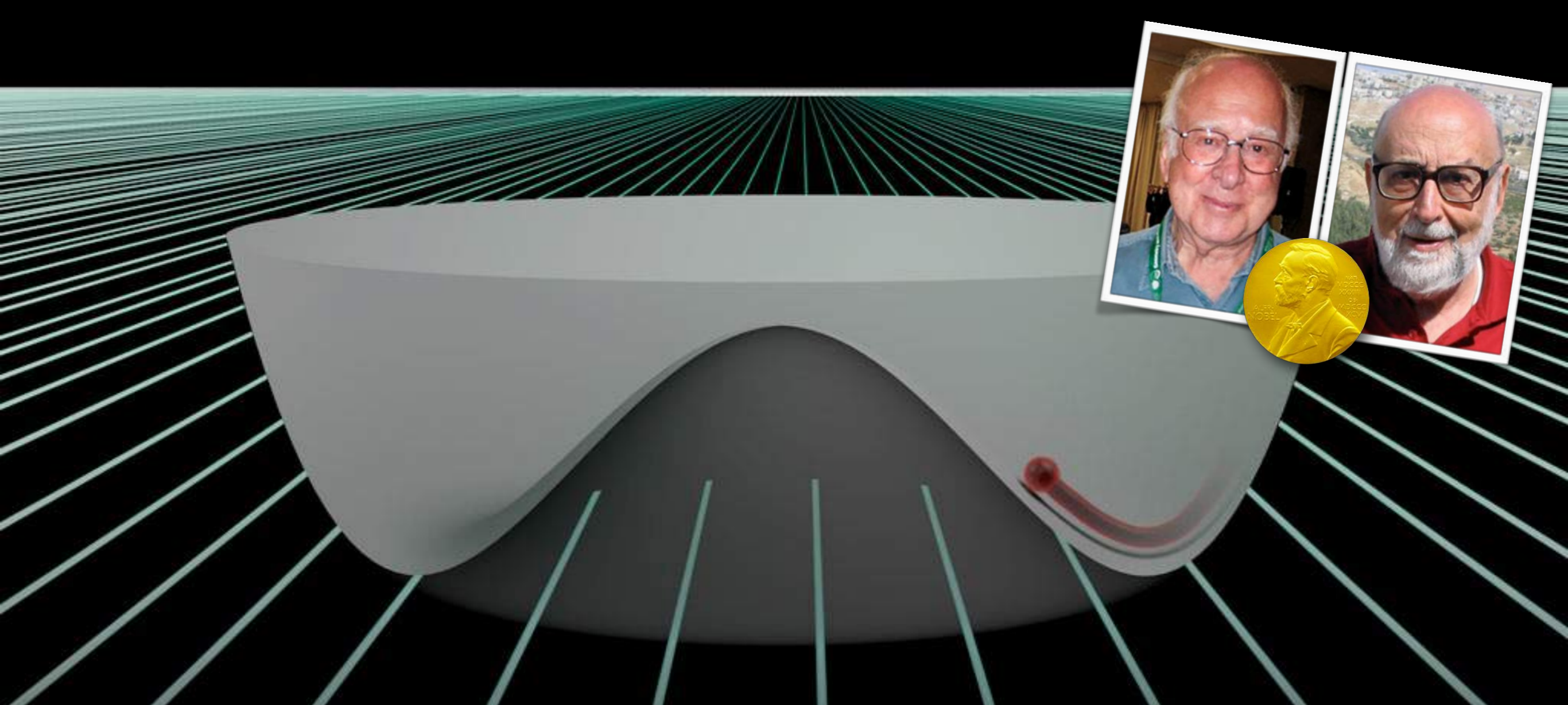

'Higgs' Amplitude Mode in Flatland

M. Endres, T. Fukuhara, M. Cheneau, P. Schauss, D. Pekker, E. Demler, S. Kuhr & I.B.

M. Endres et al. Nature (2012)

Chubukov & Sachdev, PRB 1993; Sachdev, PRB 1999; Zwerger, PRL 2004; Altman, Blatter, Huber, PRB 2007, PRL 2008; U. Bissbort et al. Phys. Rev. Lett. (2011); D. Podolsky, A. Auerbach, D. Arovas, PRB 2011

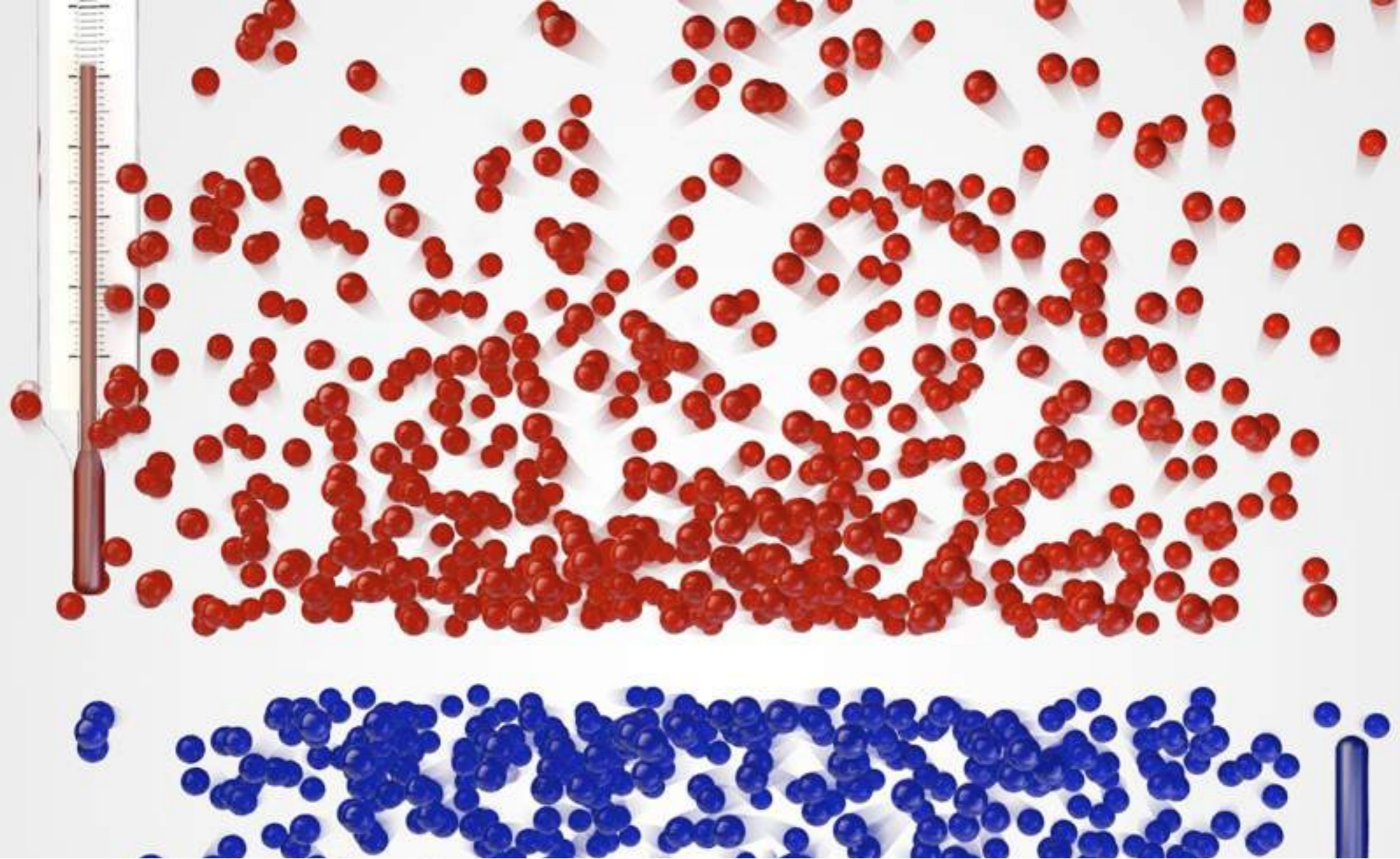

Quantum Matter at Negative Absolute Temperature

S. Braun, J.-P. Ronzheimer, M. Schreiber, S. Hodgman, T. Rom, D. Garbe, IB, U. Schneider

S. Braun et al. Science **339**, 52 (2013)

A. Mosk, PRL **95**, 040403 (2005), A. Rapp, S. Mandt & A. Rosch, PRL **105**, 220405 (2010)



Search



Listen to Fox News Radio Live >

Home Video Politics U.S.

Science Home Archaeology Air & Space

Science gets cold

By Charles Choi / February 24, 2013



WIRED

GEAR SCIENCE ENTERTAINMENT BUSINESS SECURITY DESIGN OPINION VIDEO



MAIN MENU MY STORIES: 25 FORUMS SUBSCRIBE JOBS SEARCH LOG IN

SCIENTIFIC METHOD / SCIENCE & EXPLORATION

Entropy drop: Scientists create "negative temperature" system



Negative Temperatures That Are Hotter Than The Sun

January 04, 2013 1:21 PM



Listen to the Story
Talk of the Nation

Science

MAGAZINE OF THE SOCIETY FOR

Explore

LATEST

NEWS
Hottest temperature ever measured is a negative one
BY ANDREW GRANT 10:38PM, JANUARY 4, 2013

VIEWS

SCIENCE TICKER
Transport method within cells wins Nobel Prize in Medicine or Physiology

mea

Ultracold gas sets
BY ANDREW GRANT 10:38PM,
Magazine issue: February

Home News & Comment

News & Comment News 2013

6 min 31 sec

+ Playlist
↓ Download

NATURE | NEWS

Quantum gas goes below absolute zero





Uncertain **PRINCIPLES**

with **CHAD ORZEL** 

PHYSICS, POLITICS, POP CULTURE

What Does "Negative Temperature" Mean, Anyway?

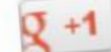
Posted by **Chad Orzel** on January 8, 2013

 (10)
  Like 45
  Tweet 31
  +1 58
  More »



3, 2013

Temperature?

...ence is measured in Kelvins (K) ...

... has an article entitled "Ne...

... potassium ions th...

American Physical Society Sites: [APS](#) | [Journals](#) | [PhysicsCentral](#) | [Physics](#)

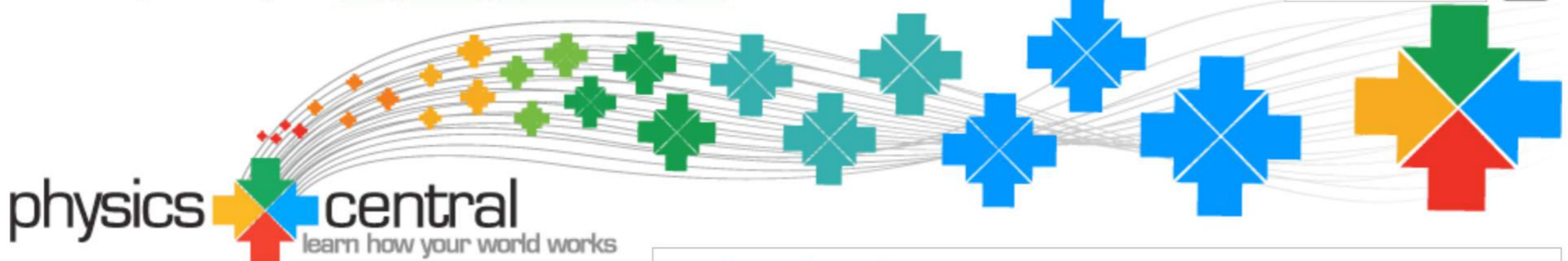

[Explore the Science](#) • [Ask & Experiment](#) • [Physics Buzz](#)

Explore the Science

Physics in Action

Physics +

Below Absolute Zero: Negative Temperatures Explained

Absolute zero, or 0 degrees Kelvin, is the temperature where all motion stops. It's the lowest limit on the temperature scale, but recent news articles have heralded a dip below that limit in a physics lab. Is absolute zero less absolute than we thought? Read on to find out.

Latest from Physics in Action

Element 115 and the Island of Stability

Ununpentium, the





Negative Temperatures are HOT - Sixty Symbols

Sixty Symbols  [Subscribe](#) 639K

817,584 views





+ Add to Share More

12,930 335

Published on 12 Mar 2013
Temperatures below absolute zero are HOTTER than those above, explains Professor Philip Moriarty. More Daisy pics:

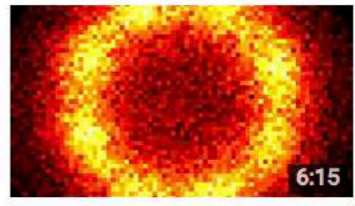
Up next

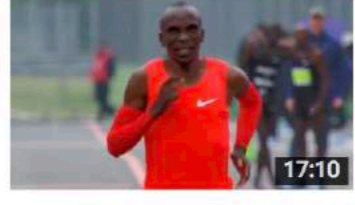
Autoplay

-  **Antihydrogen - Sixty Symbols**
Sixty Symbols
407,279 views
6:15
-  **Do Atoms Ever Touch?**
Sixty Symbols
389,080 views
12:05
-  **Superluminal Speeds (faster than light) - Sixty Symbols**
Sixty Symbols
302,780 views
8:26
-  **Sub 2 Hour Marathon - NIKE #BREAKING2 Attempt**
Great Runners
Recommended for you **NEW**
17:10
-  **The Case for String Theory - Sixty Symbols**
Sixty Symbols
236,008 views
17:56
-  **What confuses a physicist?**
Sixty Symbols
598,551 views
3:38

Can human beings sense
magnetic fields? *p. 1508*

Challenges of encoding morality into
autonomous vehicles *pp. 1514 & 1573*

The true measures of
carrier mobility *p. 1521*

Science

\$15
24 JUNE 2016
sciencemag.org

AAAS

STAYING IN
SHAPE

Disorder puts a damper on
atoms spreading out *p. 1547*

Beyond Statistical Mechanics

Many-Body Localization

The world best clocks:

- ▶ **Navigation, Positioning**
GPS, GLONASS, deep space probes
- ▶ **Geodesy**
Dating of millisecond pulsars
- ▶ **VLBI**
- ▶ **Synchronisation of distant clocks**
IAT
- ▶ **Fundamental physics tests**
Ex : general relativity
Search for a drift of the fine structure constant α :
 $\dot{\alpha}/\alpha$ at $10^{-16}/\text{year}$



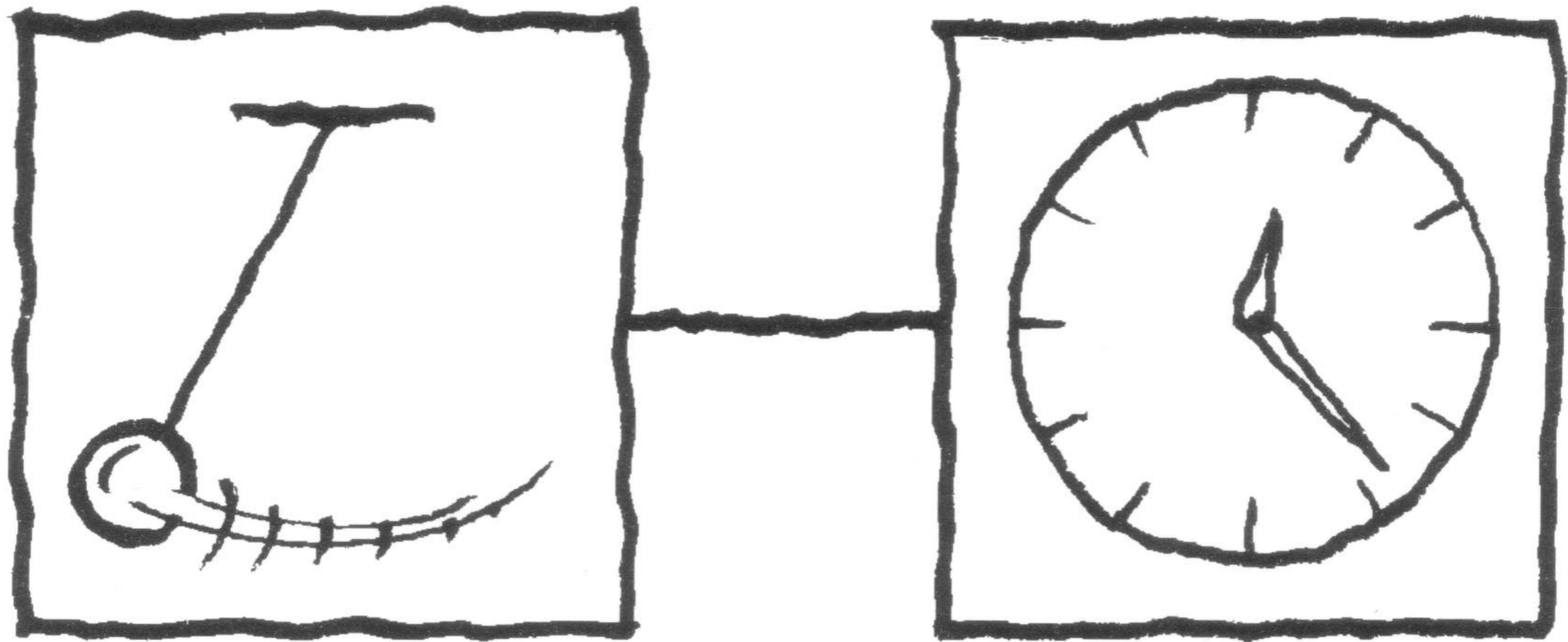

Clock = Oscillator + Counter

Sundial since 3500 v. Chr.

One period per day



Sundial since 3500 v. Chr.

One period per day

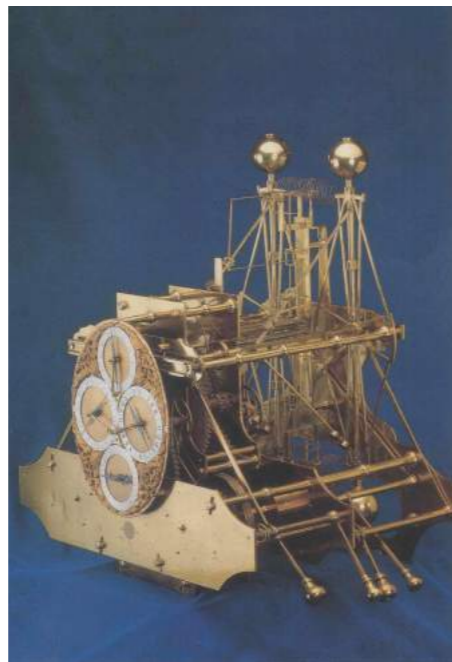

Pendulum clock since 1656

One period per second

Sundial since 3500 v. Chr.

One period per day



Quartz oscillator since 1918

32.768 periods per second

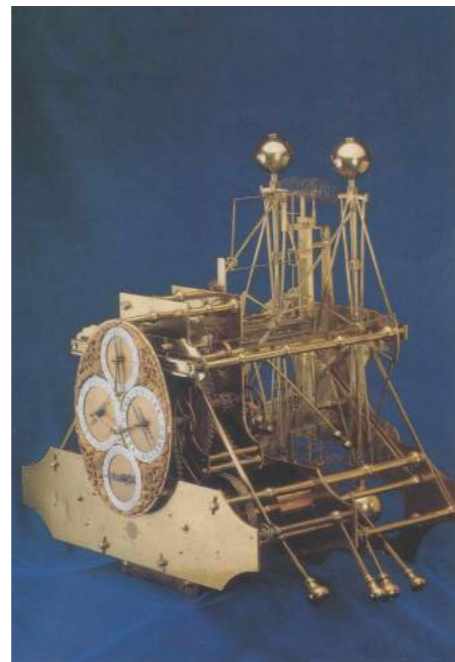

Pendulum clock since 1656

One period per second

Sundial since 3500 v. Chr.
One period per day



Quartz oscillator since 1918
32.768 periods per second

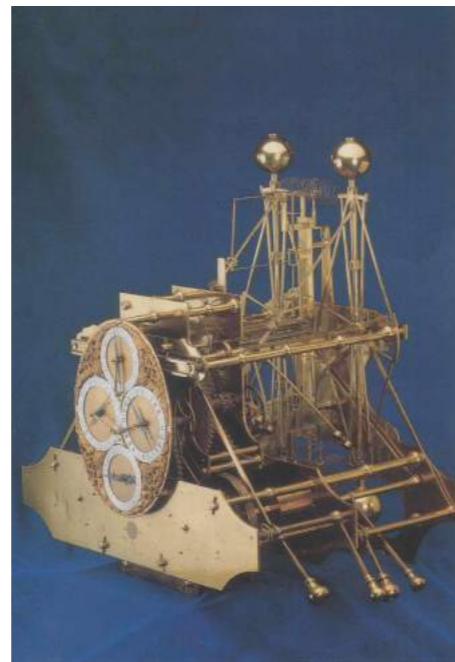

Pendulum clock since 1656
One period per second



Cesium atomic clock since 1955
9.192.631.770 oscillations per second

8 fountains in operation at SYRTE, PTB, NIST, USNO, Penn St, IEN, ON. 5 with accuracy at $1 \cdot 10^{-15}$. More than 10 under construction.

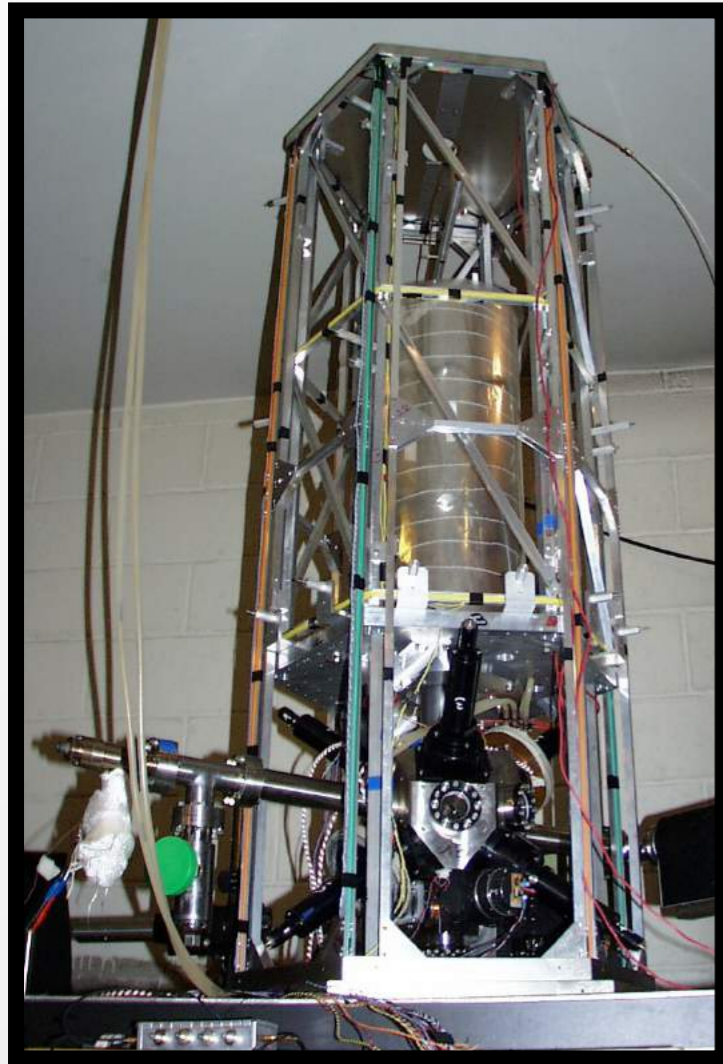

BNM-SYRTE, FR



PTB, D

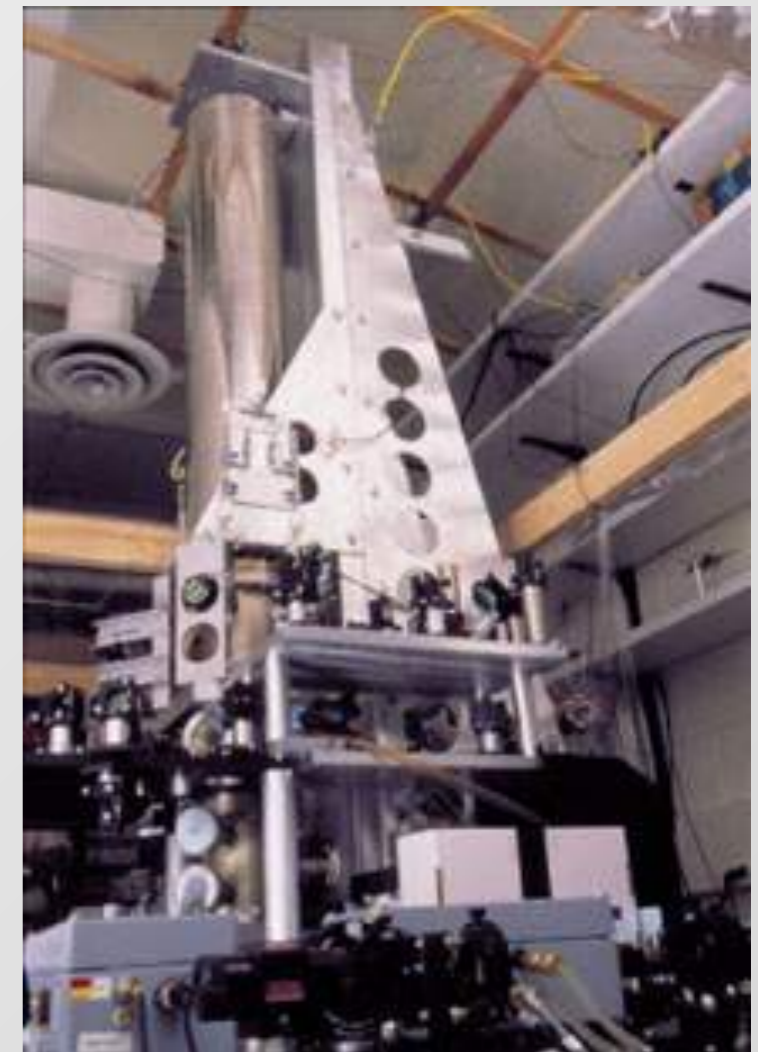

NIST, USA



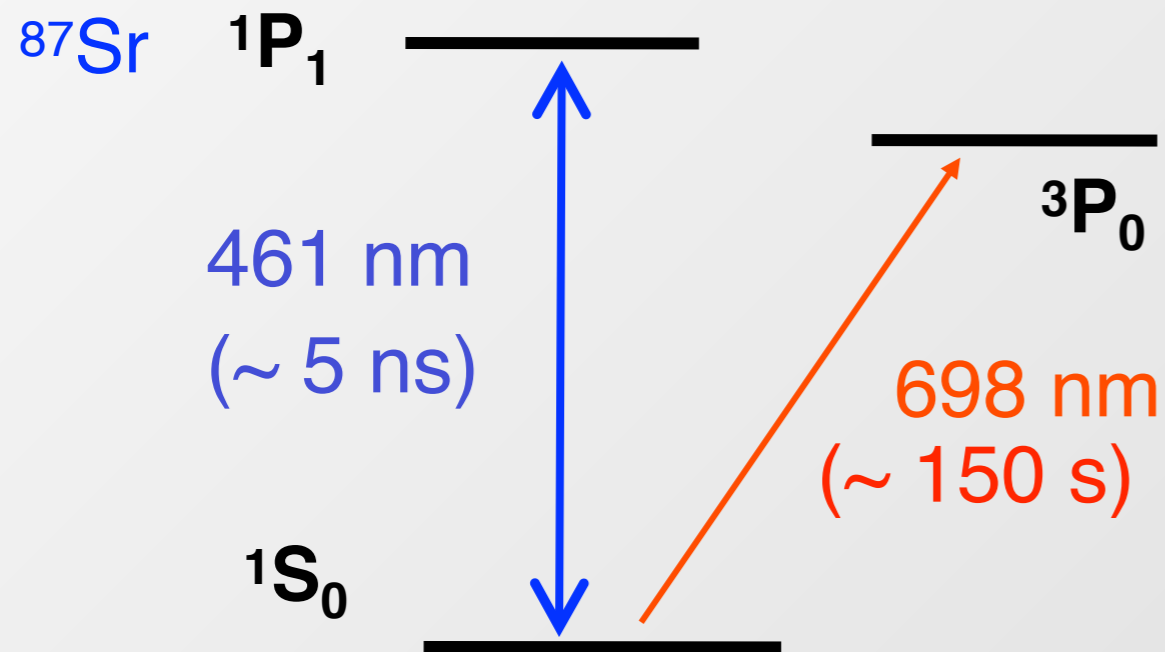
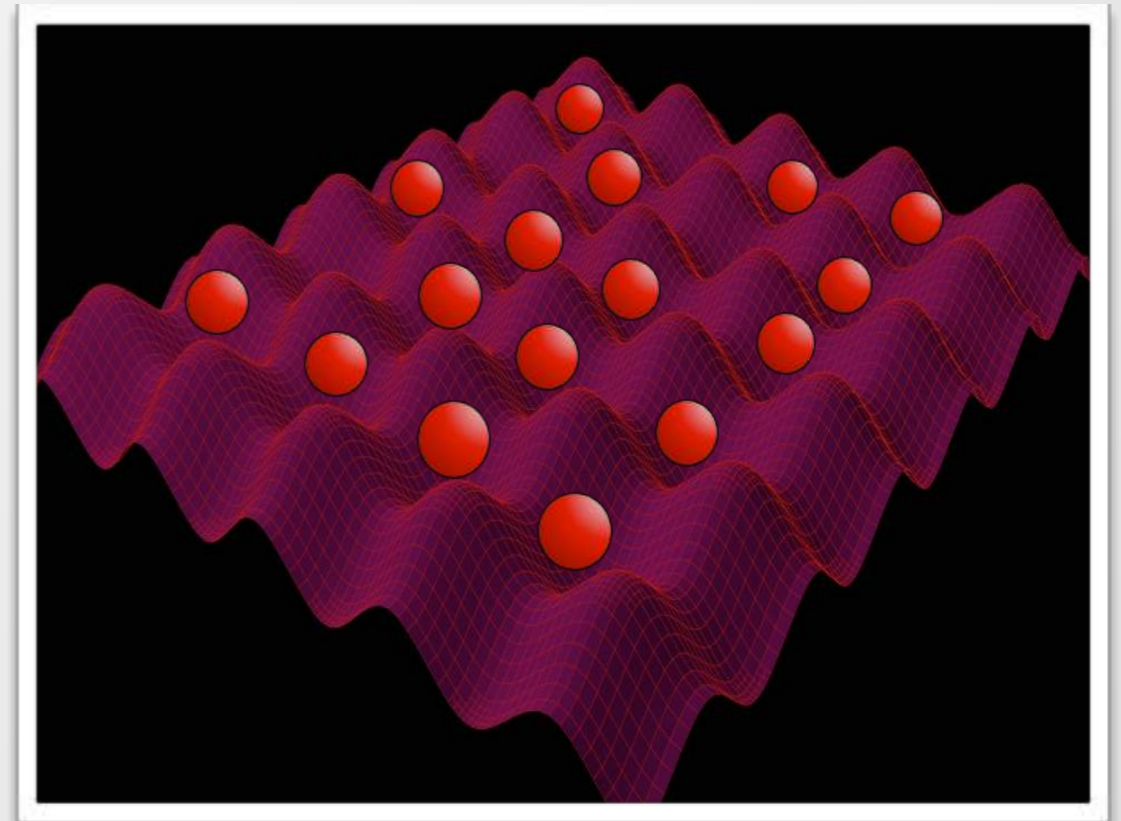
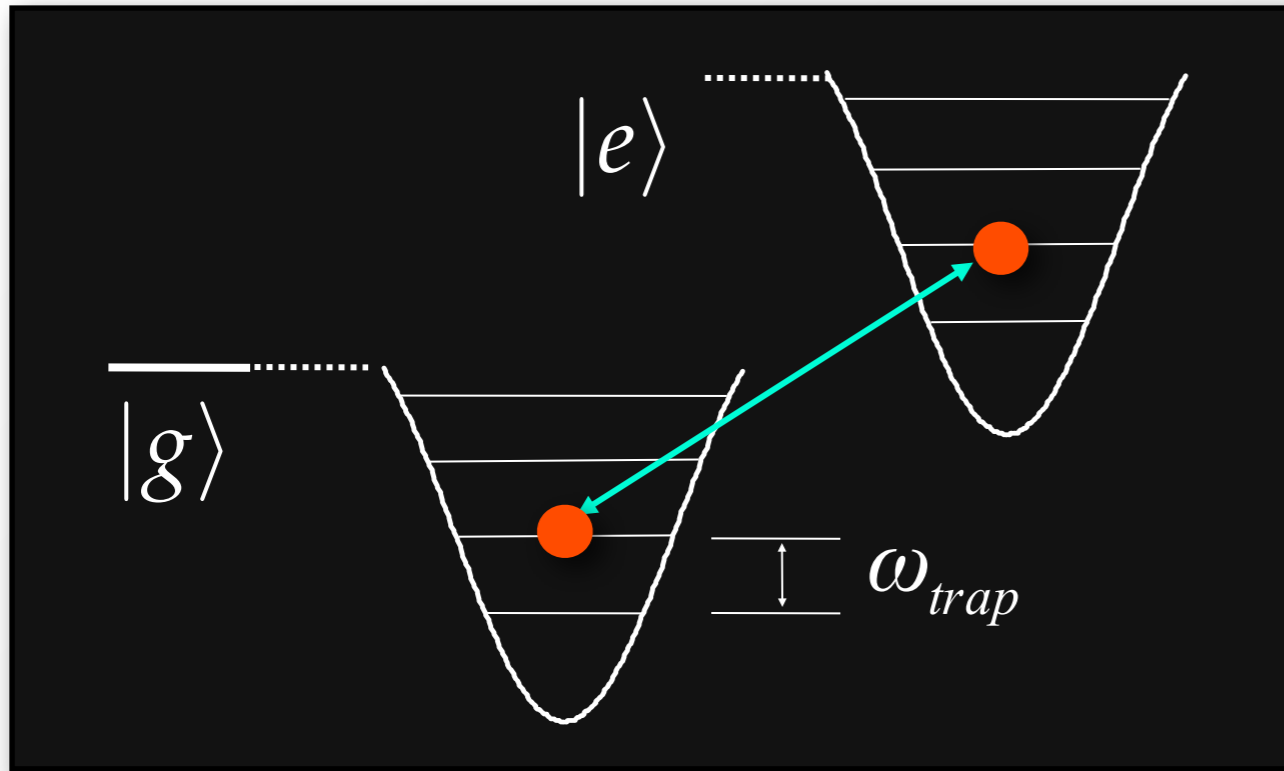

Quality factor $> 10^{17}$

Optical dipole moment
 $\sim 10^{-4} - 10^{-5}$ Debye

Boyd et al., Science **314**, 1430 (2006).



The inaccuracy of such a clock corresponds to 1s over the entire lifetime of the universe!

Outlook

- Search for New Phases of Matter
- Extremely Strong Magnetic Field Physics
- Novel Quantum Magnets
- Controlled Quasiparticle Manipulations
- Non-Equilibrium Dynamics (Universality?)
- Thermalization in Isolated Quantum Systems
- Entanglement Measures in Dynamics
- Supersolids
- Cosmology - Black Hole Models?
- High Energy Physics/String Theory
- New clocks/Navigation

**Quantitative testbeds
for theory!**

⋮

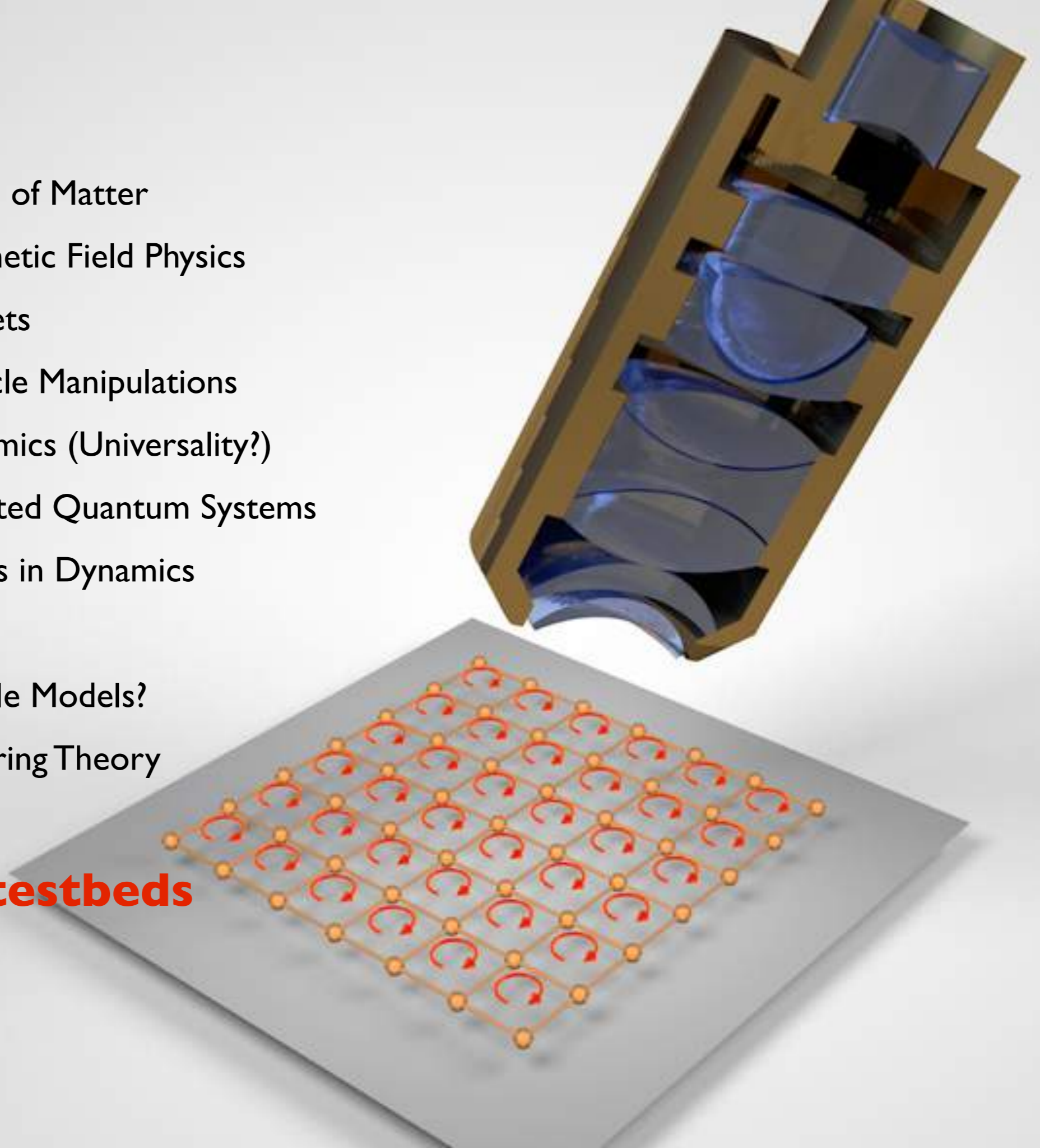



www.quantum-munich.de

Groups of: E. Altman, I. Bloch, J. Dalibard & P. Zoller



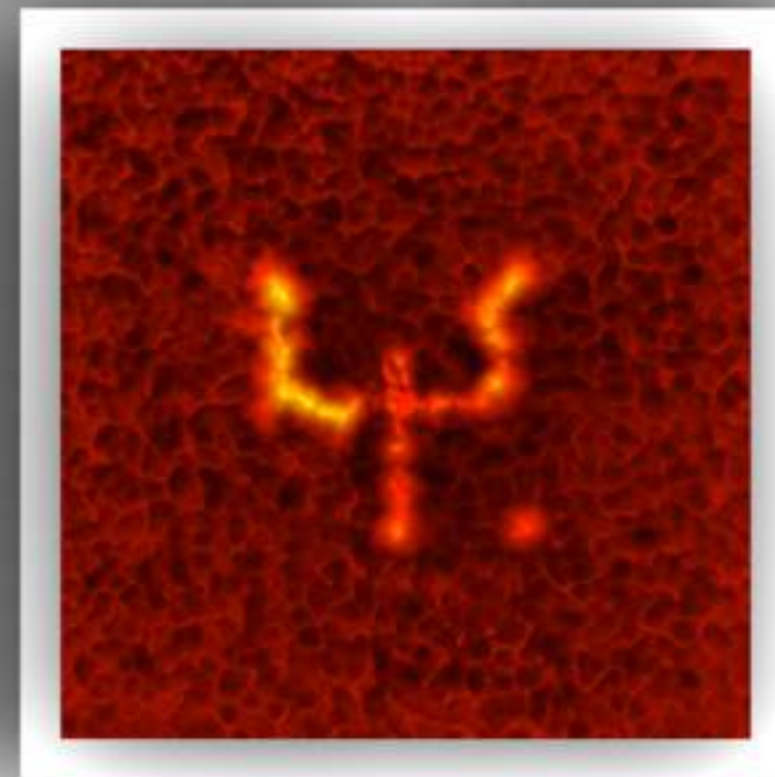
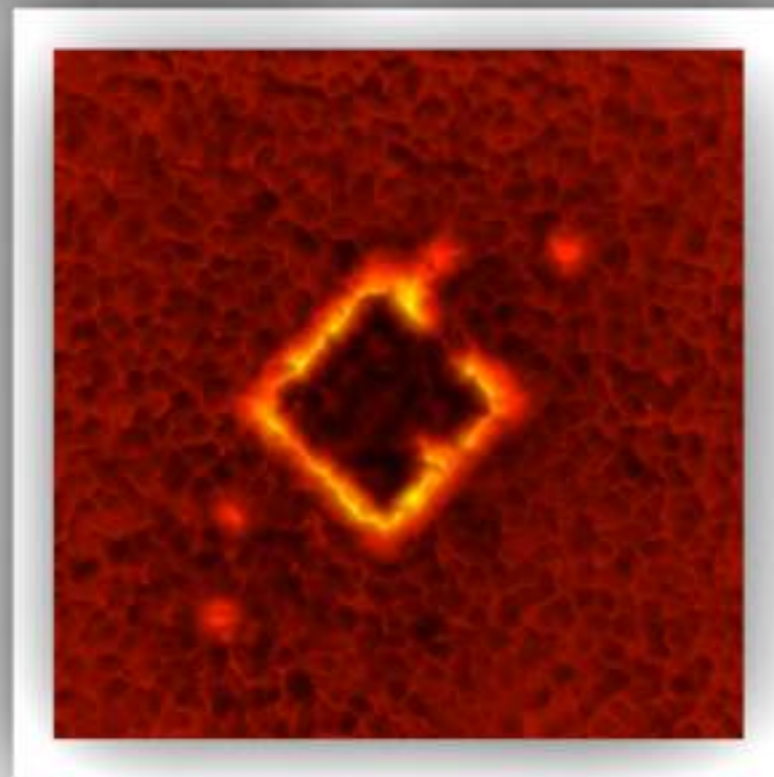
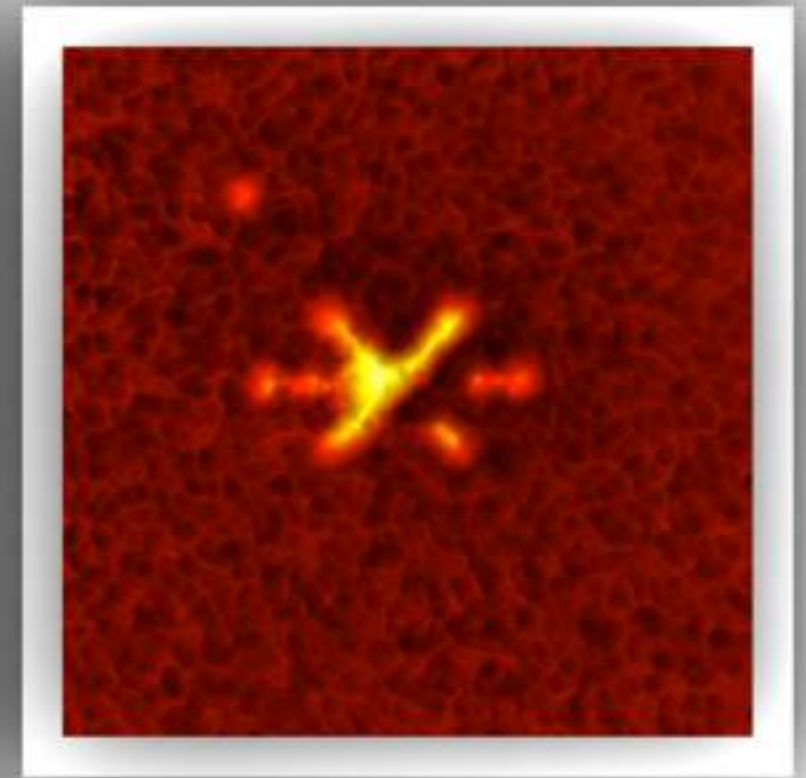
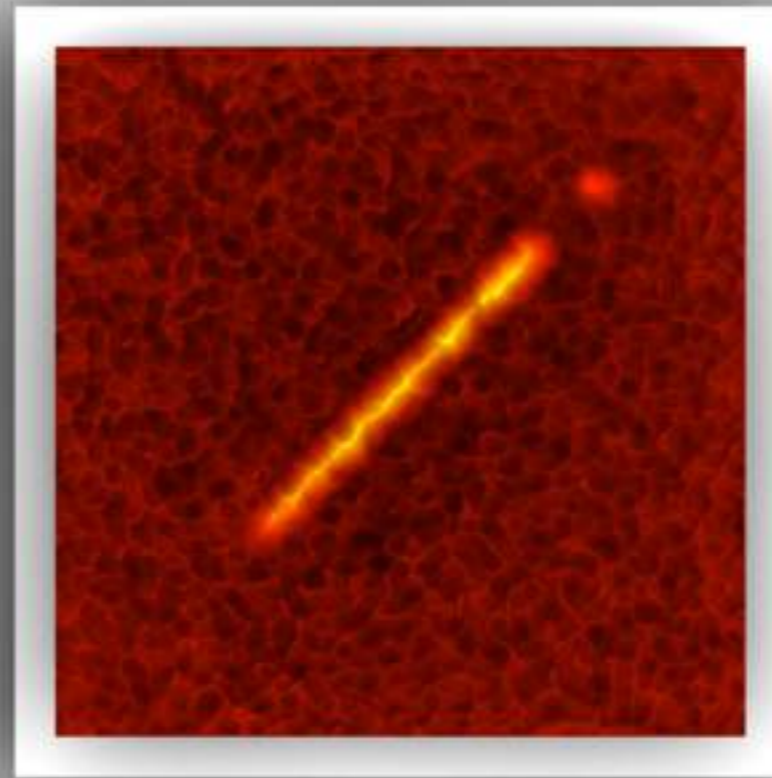
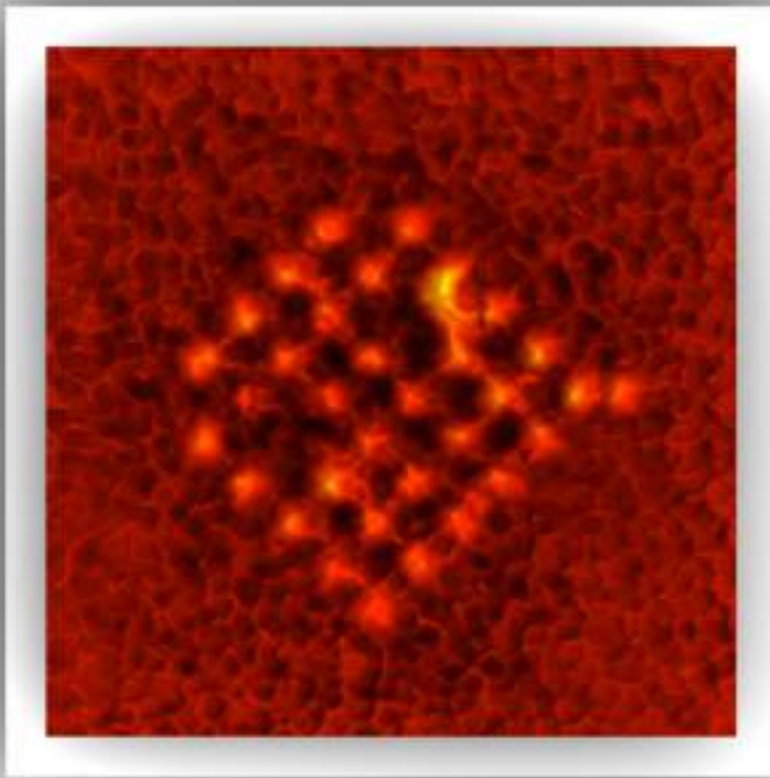

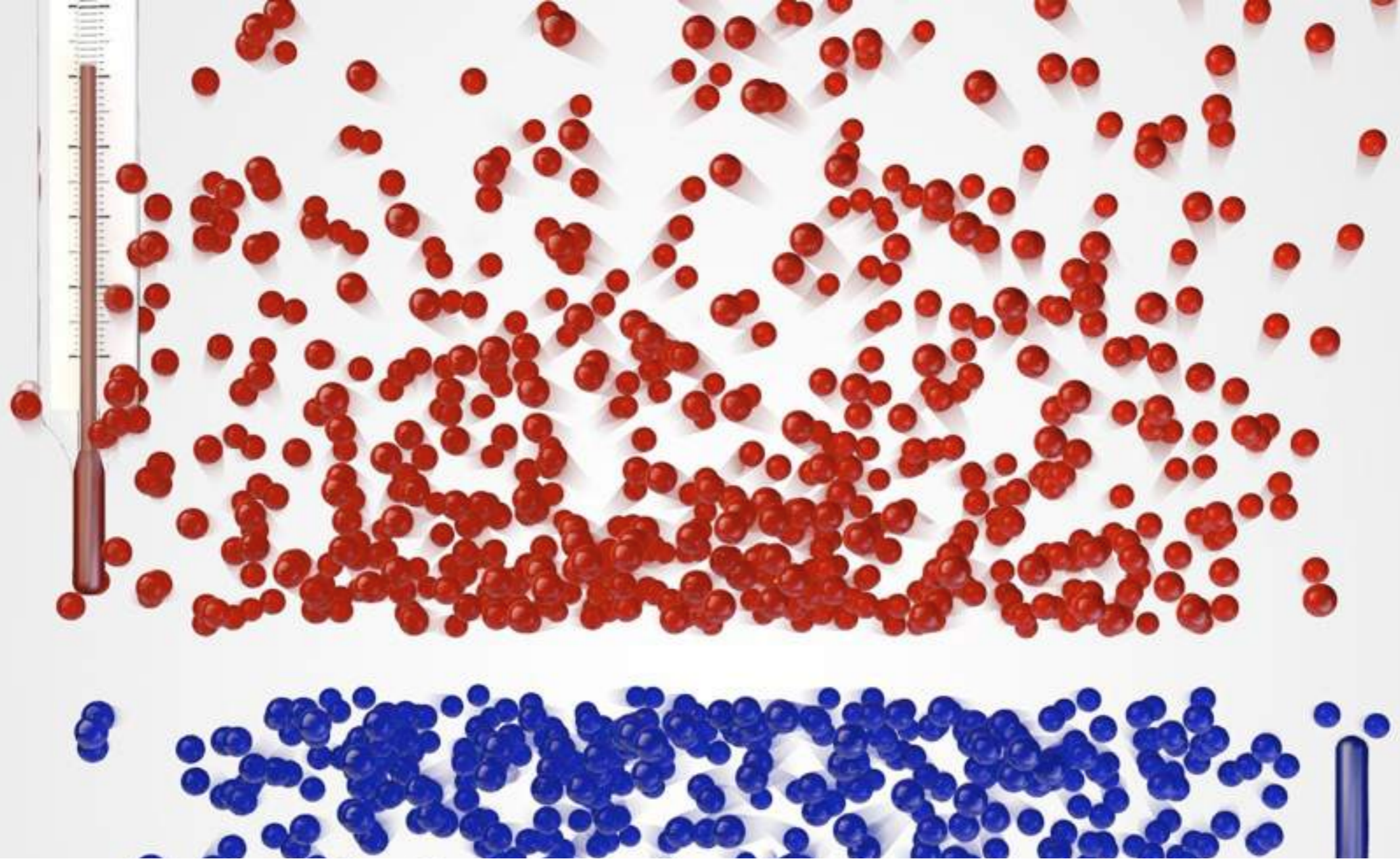

Quantum Matter at Negative Absolute Temperature

S. Braun, J.-P. Ronzheimer, M. Schreiber, S. Hodgman, T. Rom, D. Garbe, IB, U. Schneider

S. Braun et al. Science **339**, 52 (2013)

A. Mosk, PRL **95**, 040403 (2005), A. Rapp, S. Mandt & A. Rosch, PRL **105**, 220405 (2010)

$$\frac{1}{T} = \left(\frac{\partial S}{\partial E} \right)_V$$

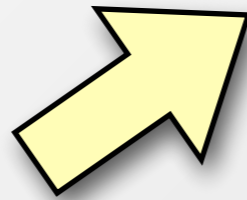

Positive Temperature

Entropy increases with Energy

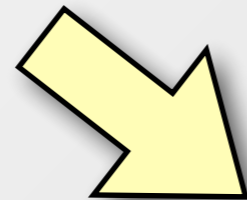

Negative Temperature

Entropy decreases with Energy



$$\frac{1}{T} = \left(\frac{\partial S}{\partial E} \right)_V$$

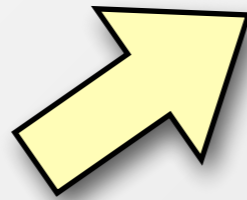

Positive Temperature

Entropy increases with Energy

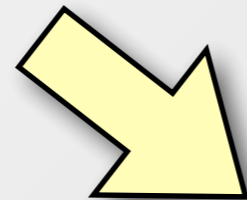

Negative Temperature

Entropy decreases with Energy

Thermodynamic theorems apply in negative as well as positive temperature regime!



$$\frac{1}{T} = \left(\frac{\partial S}{\partial E} \right)$$

Warning:
Temperature
does not measure
energy content!!!

Temperature
increases with Energy

Temperature
decreases with Energy

Thermodynamic theorems apply in negative as well as positive temperature regime!



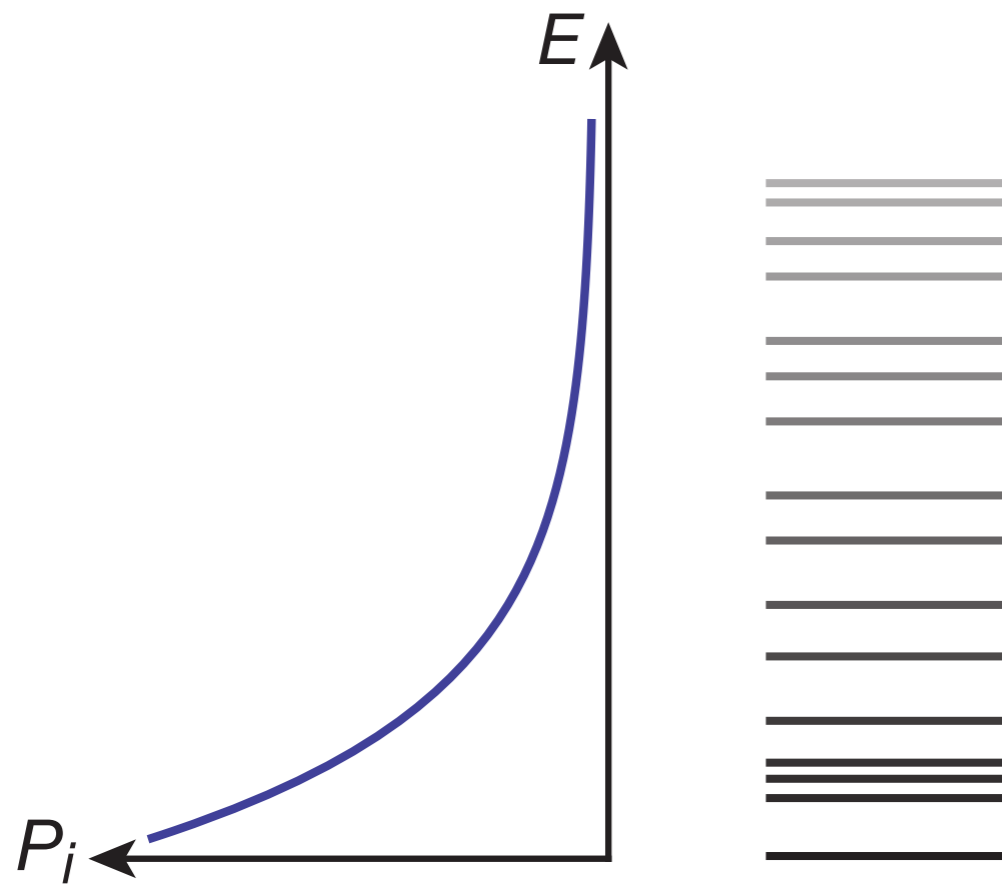

$$P_i \propto e^{-\frac{E_i}{k_B T}}$$



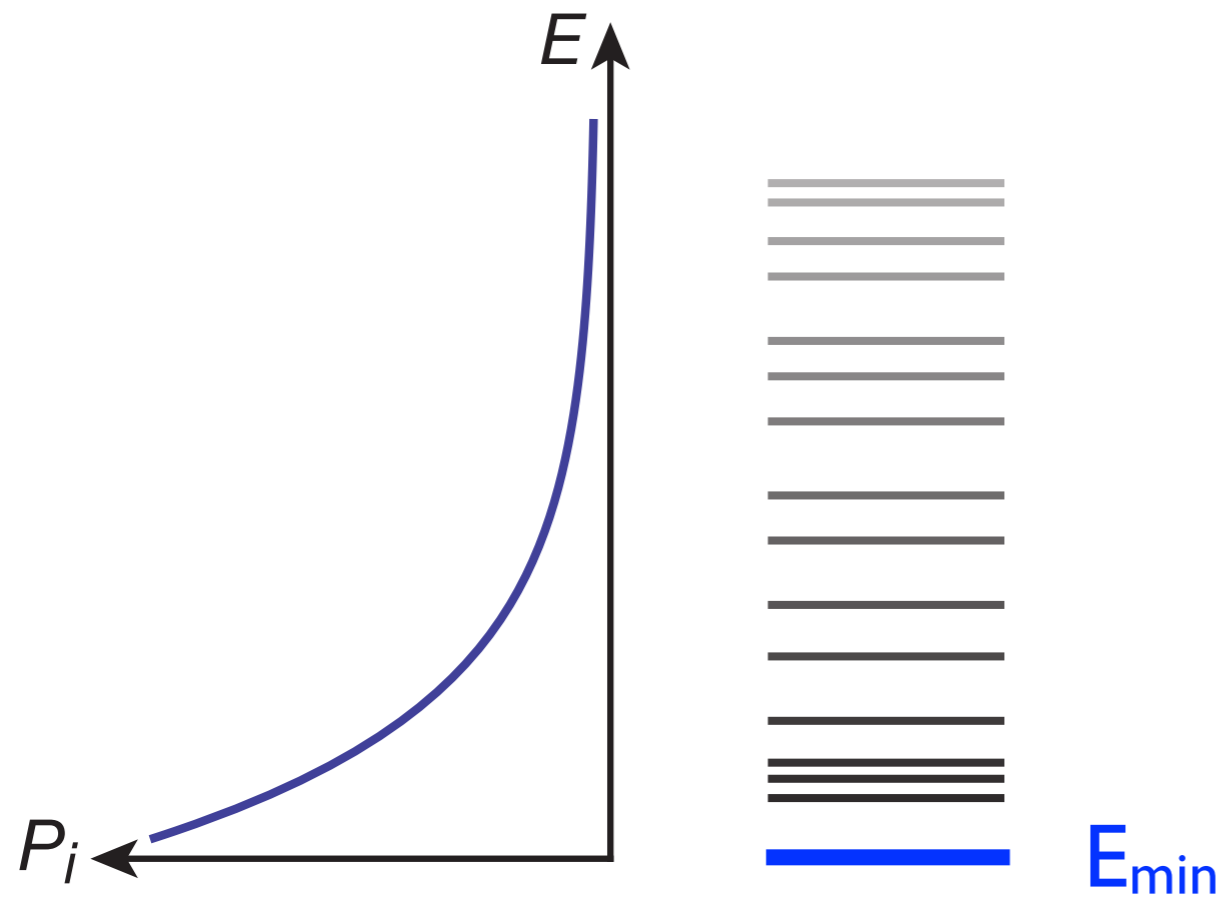

$$P_i \propto e^{-\frac{E_i}{k_B T}}$$

For positive temperatures, we require **lower energy bound** E_{\min} !



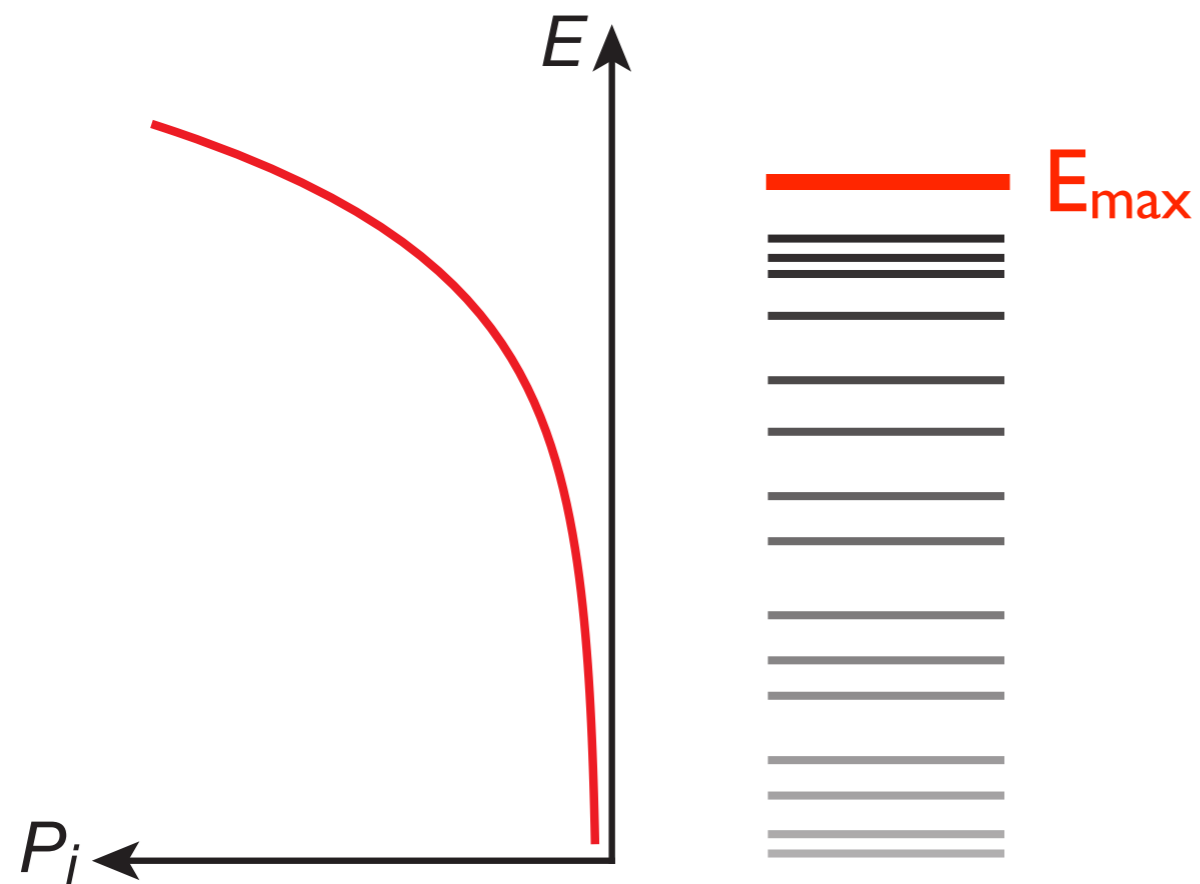

$$P_i \propto e^{-\frac{E_i}{k_B(-T)}}$$

For negative temperatures, we require **upper energy bound E_{\max}** !





Norman Ramsey
(1915-2011)

PHYSICAL REVIEW

VOLUME 103, NUMBER 1

JULY 1, 1956

Thermodynamics and Statistical Mechanics at Negative Absolute Temperatures

NORMAN F. RAMSEY*

Harvard University, Cambridge, Massachusetts, and Clarendon Laboratory, Oxford, England

(Received March 26, 1956)

As discussed in Sec. III below, the conditions for the existence of a system at negative temperatures are so restrictive that they are rarely met in practice except with some mutually interacting nuclear spin systems.

L. Onsager, N. Cim. **6**, 279 (1949)

E.M. Purcell & R.V. Pound, Phys. Rev. **81**, 279 (1951)

N. Ramsey, Phys. Rev. **103**, 20 (1956)

M.J. Klein, Phys. Rev. **104**, 589 (1956)

P. Hakonen & O. Lounasmaa, Science **265**, 1821 (1994)

P. Medley et al, Phys. Rev. Lett **106**, 195301 (2011)





Norman Ramsey
(1915-2011)

PHYSICAL REVIEW

VOLUME 103, NUMBER 1

JULY 1, 1956

Thermodynamics and Statistical Mechanics at Negative Absolute Temperatures

NORMAN F. RAMSEY*

Harvard University, Cambridge, Massachusetts, and Clarendon Laboratory, Oxford, England

(Received March 26, 1956)

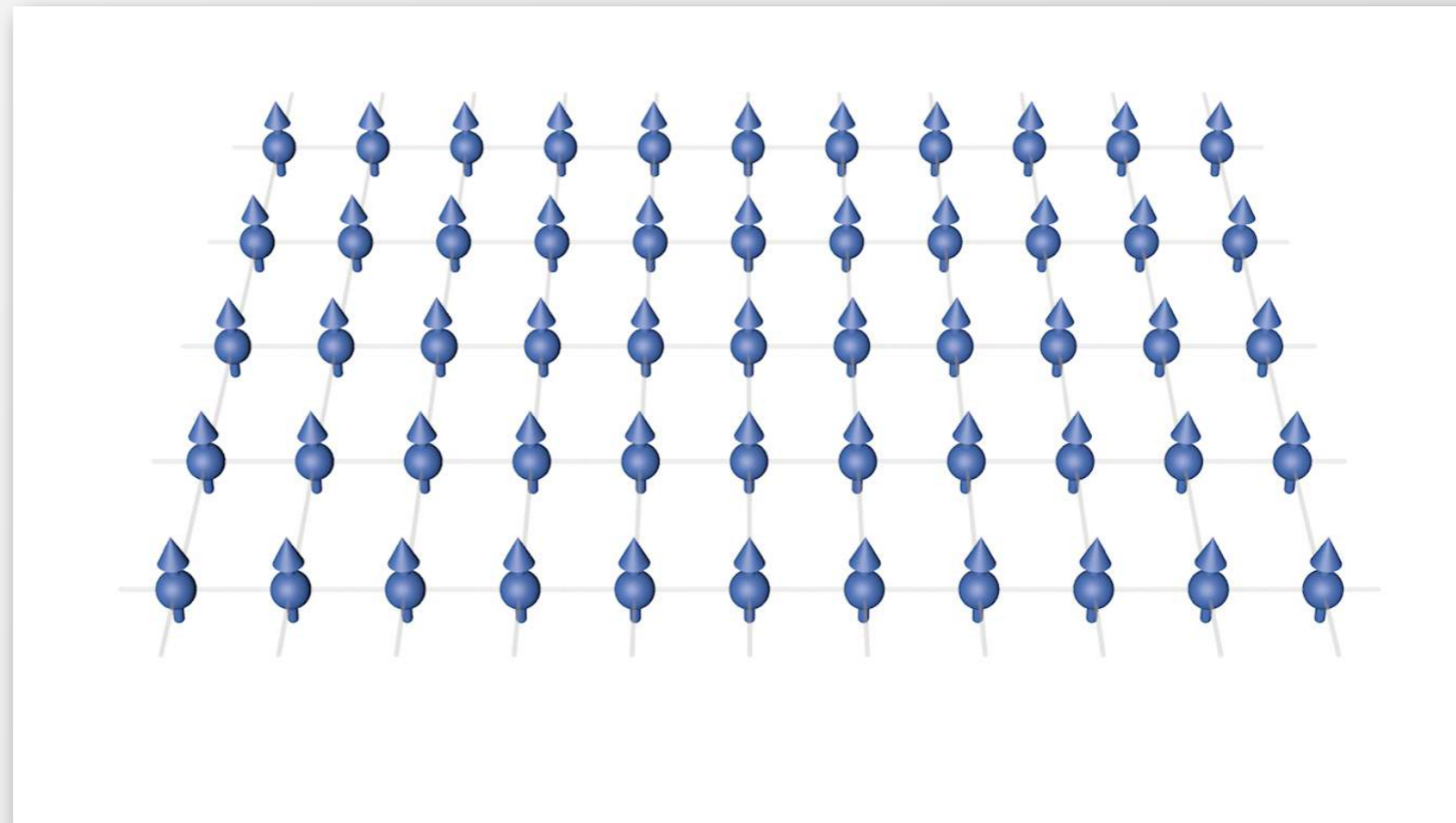

Lowest Energy State E_{min}

- L. Onsager, N. Cim. **6**, 279 (1949)
- E.M. Purcell & R.V. Pound, Phys. Rev. **81**, 279 (1951)
- N. Ramsey, Phys. Rev. **103**, 20 (1956)
- M.J. Klein, Phys. Rev. **104**, 589 (1956)
- P. Hakonen & O. Lounasmaa, Science **265**, 1821 (1994)
- P. Medley et al, Phys. Rev. Lett **106**, 195301 (2011)

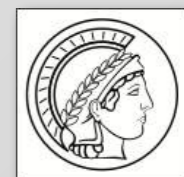



Norman Ramsey
(1915-2011)

PHYSICAL REVIEW

VOLUME 103, NUMBER 1

JULY 1, 1956

Thermodynamics and Statistical Mechanics at Negative Absolute Temperatures

NORMAN F. RAMSEY*

Harvard University, Cambridge, Massachusetts, and Clarendon Laboratory, Oxford, England

(Received March 26, 1956)

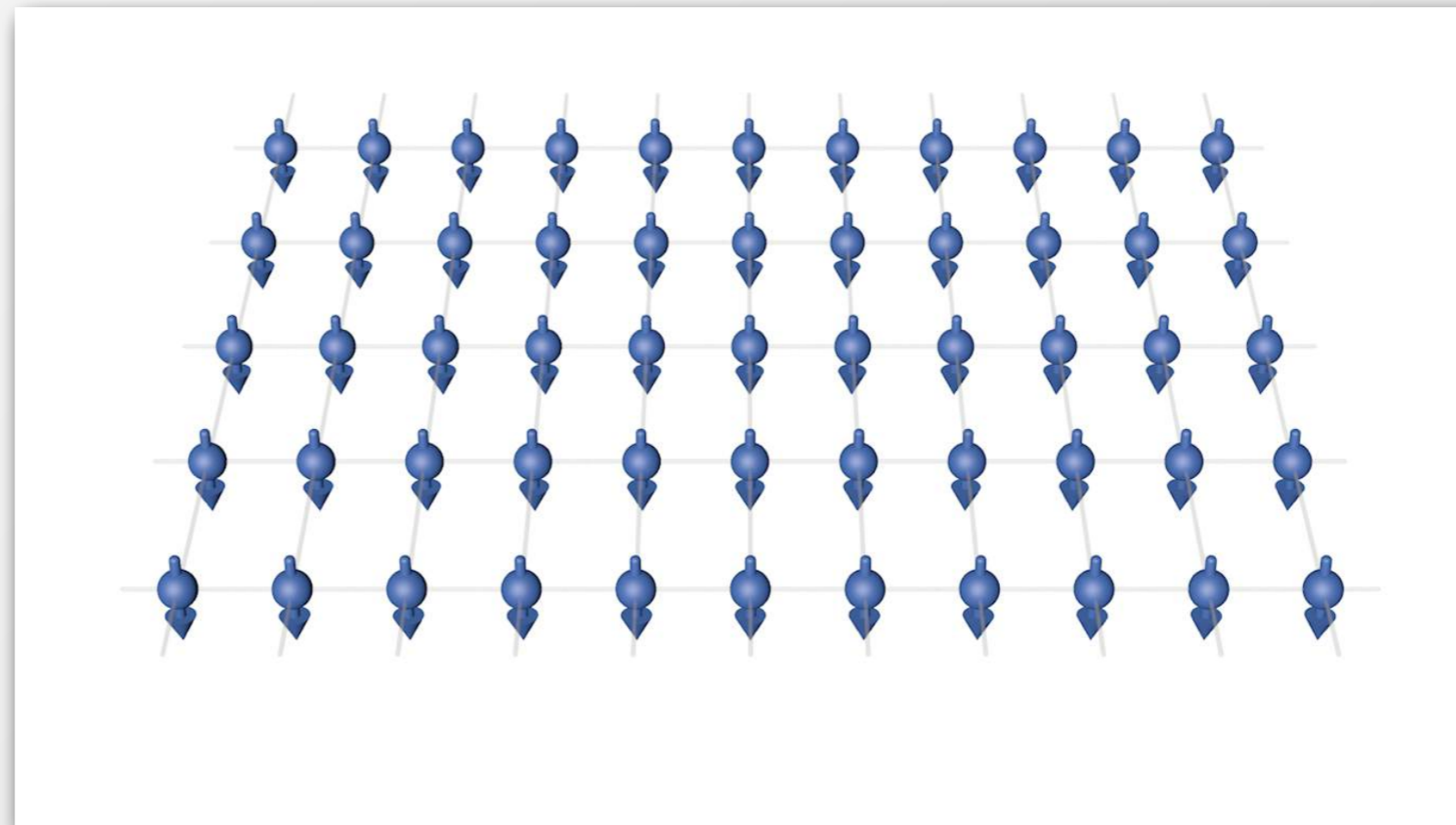

Highest Energy State E_{max}

- L. Onsager, N. Cim. **6**, 279 (1949)
- E.M. Purcell & R.V. Pound, Phys. Rev. **81**, 279 (1951)
- N. Ramsey, Phys. Rev. **103**, 20 (1956)
- M.J. Klein, Phys. Rev. **104**, 589 (1956)
- P. Hakonen & O. Lounasmaa, Science **265**, 1821 (1994)
- P. Medley et al, Phys. Rev. Lett **106**, 195301 (2011)

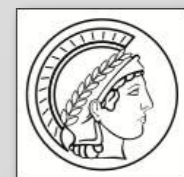



Norman Ramsey
(1915-2011)

- L. Onsager, N. Cim. **6**, 279 (1949)
- E.M. Purcell & R.V. Pound, Phys. Rev. **81**, 270 (1951)
- N. Ramsey, Phys. Rev. **103**, 20 (1956)
- M.J. Klein, Phys. Rev. **104**, 589 (1956)
- P. Hakonen & O. Lounasmaa, Science **265**, 1232 (1994)
- P. Medley et al, Phys. Rev. Lett **106**, 195301 (2011)

PHYSIC

The

A Nuclear Spin System at Negative Temperature

E. M. PURCELL AND R. V. POUND

Department of Physics, Harvard University, Cambridge, Massachusetts

November 1, 1950

A NUMBER of special experiments have been performed with a crystal of LiF which, as reported previously,¹ had long relaxation times both in a strong field and in the earth's field. These experiments were designed to discover the conditions determining the sense of remagnetization by a strong field when the initially magnetized crystal was put for a brief interval in the earth's field.

At field strengths allowing the system to be described by its net magnetic moment and angular momentum, a sufficiently rapid reversal of the direction of the magnetic field should result in a magnetization opposed to the new sense of the field. The reversal must occur in such a way that the time spent below a minimum effective field is so small compared to the period of the Larmor precession that the system cannot follow the change adiabatically. The experiments in zero field reported above² showed a zero field resonance at about 50 kc and therefore the following experiment was tried.

The crystal, initially at equilibrium magnetization in the strong (6376 gauss) field, was quickly removed, through the earth's field, and placed inside a small solenoid, the axis of which was

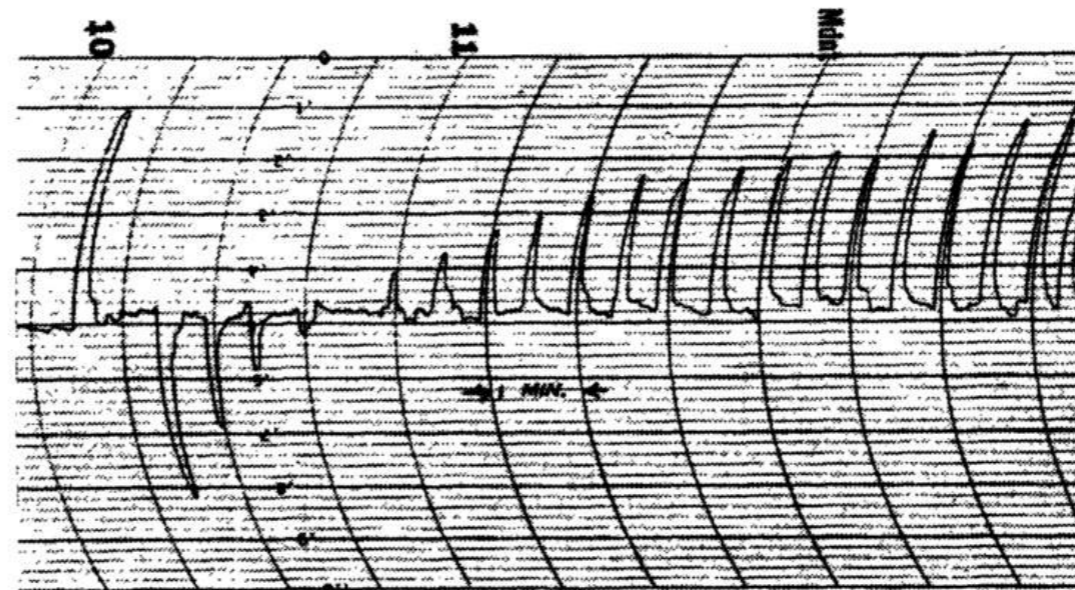

JULY 1, 1956

Absolute Temperatures

ford, England

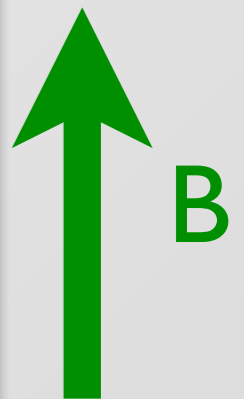
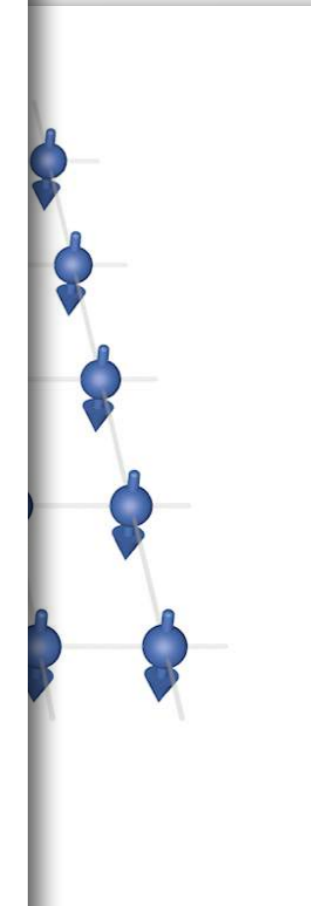

A Nuclear Spin System at Negative Temperature

E. M. PURCELL AND R. V. POUND

Department of Physics, Harvard University, Cambridge, Massachusetts

November 1, 1950

JULY 1, 1956

PHYSICS

The **A** NUMBER of special experiments have been performed with a crystal of LiF which, as reported previously,¹ had long been in a strong field and in the earth's field. Conditions deter-

bsolute Temperatures

ford, England

ARTICLES

Negative Absolute Temperatures: "Hot" Spins in Spontaneous Magnetic Order

Pertti Hakonen and Olli V. Lounasmaa

The experiment was performed at resonance at about 50 kc and therefore was tried.

The crystal, initially at equilibrium magnetization in the strong (6376 gauss) field, was quickly removed, through the earth's field, and placed inside a small solenoid, the axis of which was

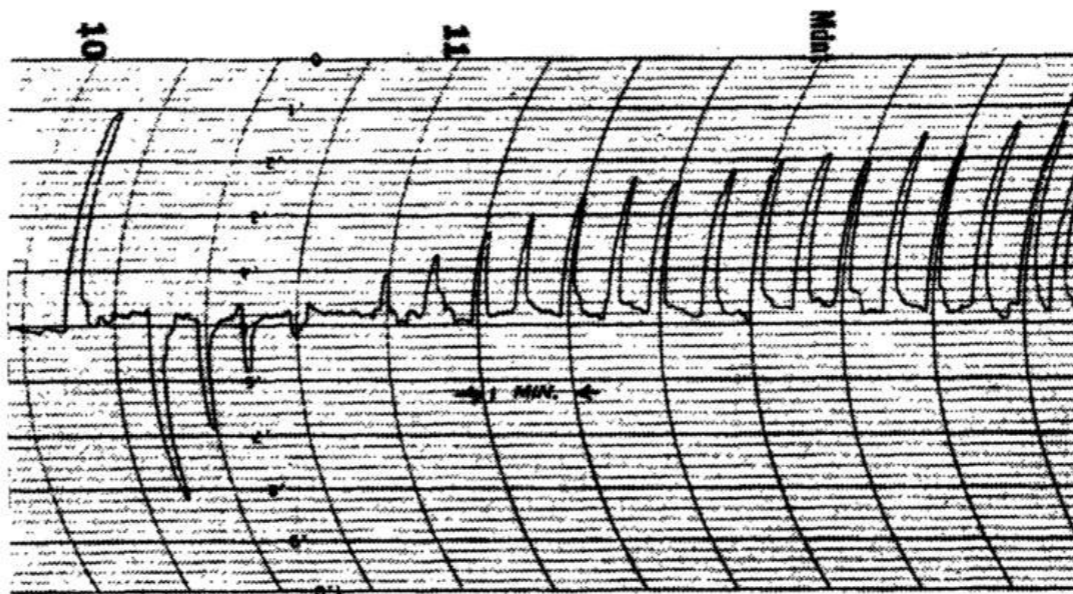

Norman Ramsey
(1915-2011)

- L. Onsager, N. Cim. **6**, 279 (1949)
- E.M. Purcell & R.V. Pound, Phys. Rev. **81**, 270 (1951)
- N. Ramsey, Phys. Rev. **103**, 20 (1956)
- M.J. Klein, Phys. Rev. **104**, 589 (1956)
- P. Hakonen & O. Lounasmaa, Science **265**, 1220 (1994)
- P. Medley et al, Phys. Rev. Lett **106**, 195301 (2011)



A Nuclear Spin System at Negative Temperature

E. M. PURCELL AND R. V. POUND

Department of Physics, Harvard University, Cambridge, Massachusetts

November 1, 1950

PHYSICS

JULY 1, 1956

The **A** NUMBER of special experiments have been performed with a crystal of LiF which, as reported previously,¹ had long been in a strong field and in the earth's field. Conditions deter-

bsolute Temperatures

ford, England

ARTICLES

Negative Absolute Temperatures: Spins in Spontaneous

week ending
13 MAY 2011

PHYSICAL REVIEW LETTERS

PRL 106, 195301 (2011)

Spin Gradient Demagnetization Cooling of Ultracold Atoms

Patrick Medley,* David M. Weld,[†] Hirokazu Miyake, David E. Pritchard, and Wolfgang Ketterle
MIT-Harvard Center for Ultracold Atoms, Research Laboratory of Electronics, and Department of Physics,
Massachusetts Institute of Technology, Cambridge, Massachusetts 02139, USA

(Received 12 January 2011; revised manuscript received 16 March 2011; published 12 May 2011)

We demonstrate a new cooling method in which a time-varying magnetic field gradient is applied to an ultracold spin mixture. This enables preparation of isolated spin distributions at positive and negative effective spin temperatures of ± 50 pK. The spin system can also be used to cool other degrees of freedom,

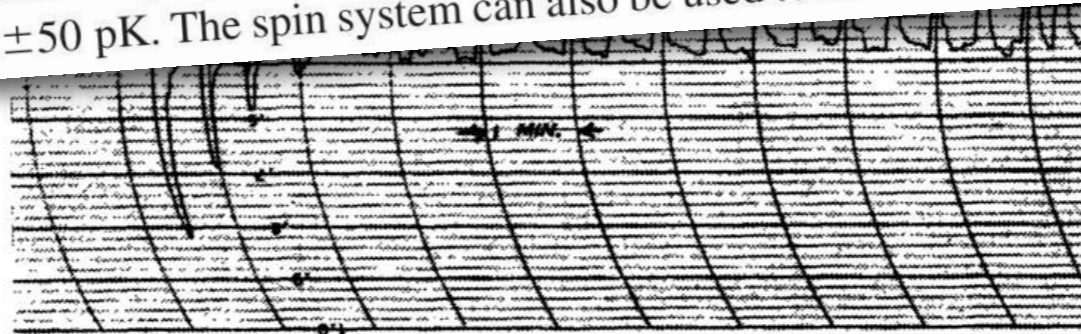

E.M. Purcell & R.V. Pound, Phys. Rev. **81**, 270 (1952)

N. Ramsey, Phys. Rev. **103**, 20 (1956)

M.J. Klein, Phys. Rev. **104**, 589 (1956)

P. Hakonen & O. Lounasmaa, Science **265**, 1017 (1994)

P. Medley et al, Phys. Rev. Lett **106**, 195301 (2011)



A Nuclear Spin System at Negative Temperature

E. M. PURCELL AND R. V. POUND

Department of Physics, Harvard University, Cambridge, Massachusetts

November 1, 1950

PHYSICS

JULY 1, 1956

The **A** NUMBER of special experiments have been performed with a crystal of LiF which, as reported previously,¹ had long been in a strong field and in the earth's field. Conditions deter-

bsolute Temperatures

ford, England

ARTICLES

Negative Spins

But how to realise in gas of moving atoms, for motional states???

week ending
13 MAY 2011

PRL 106, 195301 (2011)

Spin

Patrick Medley,*
MIT-Harvard Center for
Massachusetts
(Received 12 January

We demonstrate
ultracold spin
effective spin

... method in ... gradient is applied to an ... spin distributions at positive and negative ... temperatures of ± 50 pK. The spin system can also be used to cool other degrees of freedom,

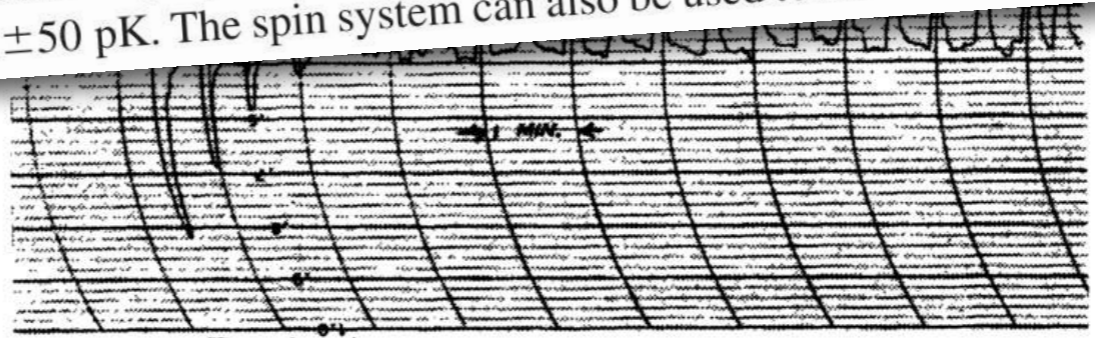

E.M. Purcell & R.V. Pound, Phys. Rev. **81**, 27

N. Ramsey, Phys. Rev. **103**, 20 (1956)

M.J. Klein, Phys. Rev. **104**, 589 (1956)

P. Hakonen & O. Lounasmaa, Science **265**

P. Medley et al, Phys. Rev. Lett **106**, 195301 (2011)



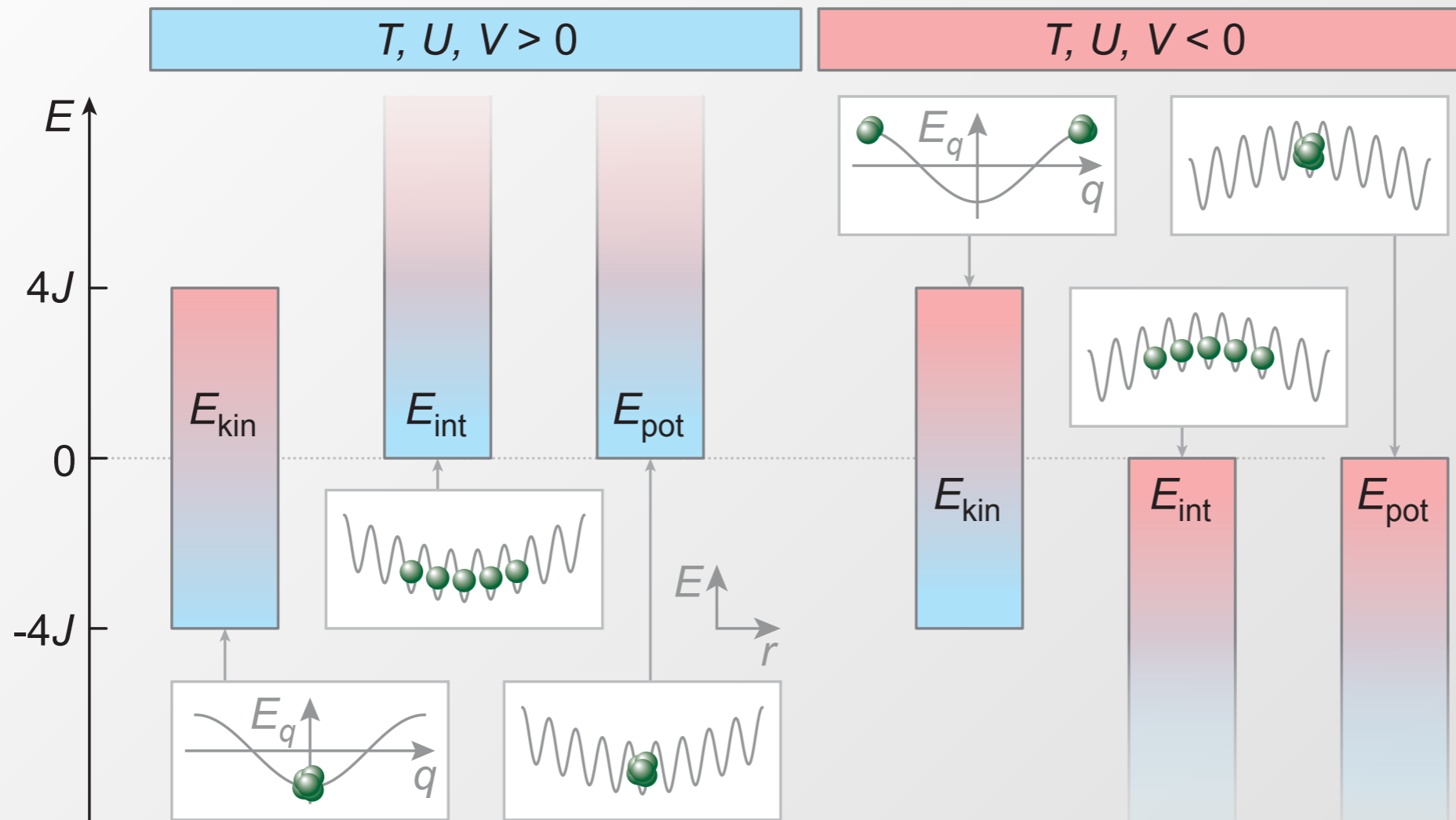

$$\hat{H} = -J \sum_{\langle i,j \rangle} \hat{a}_i^\dagger \hat{a}_j + \frac{U}{2} \sum_i \hat{n}_i (\hat{n}_i - 1) + V \sum_i \mathbf{R}_i^2 \hat{n}_i$$

$U, V < 0$ required for upper energy bound!



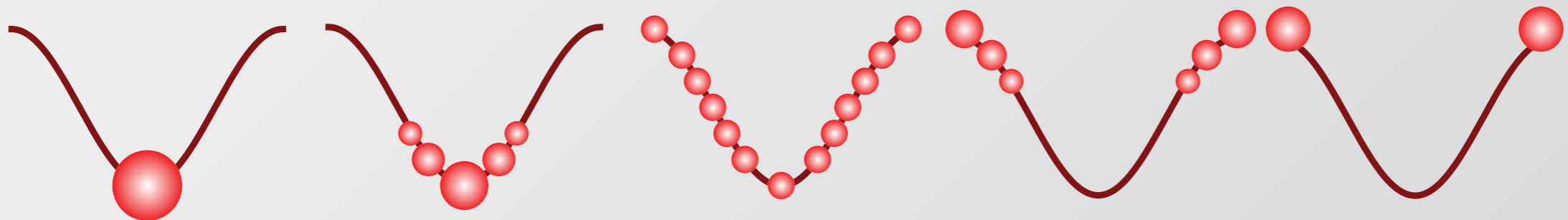
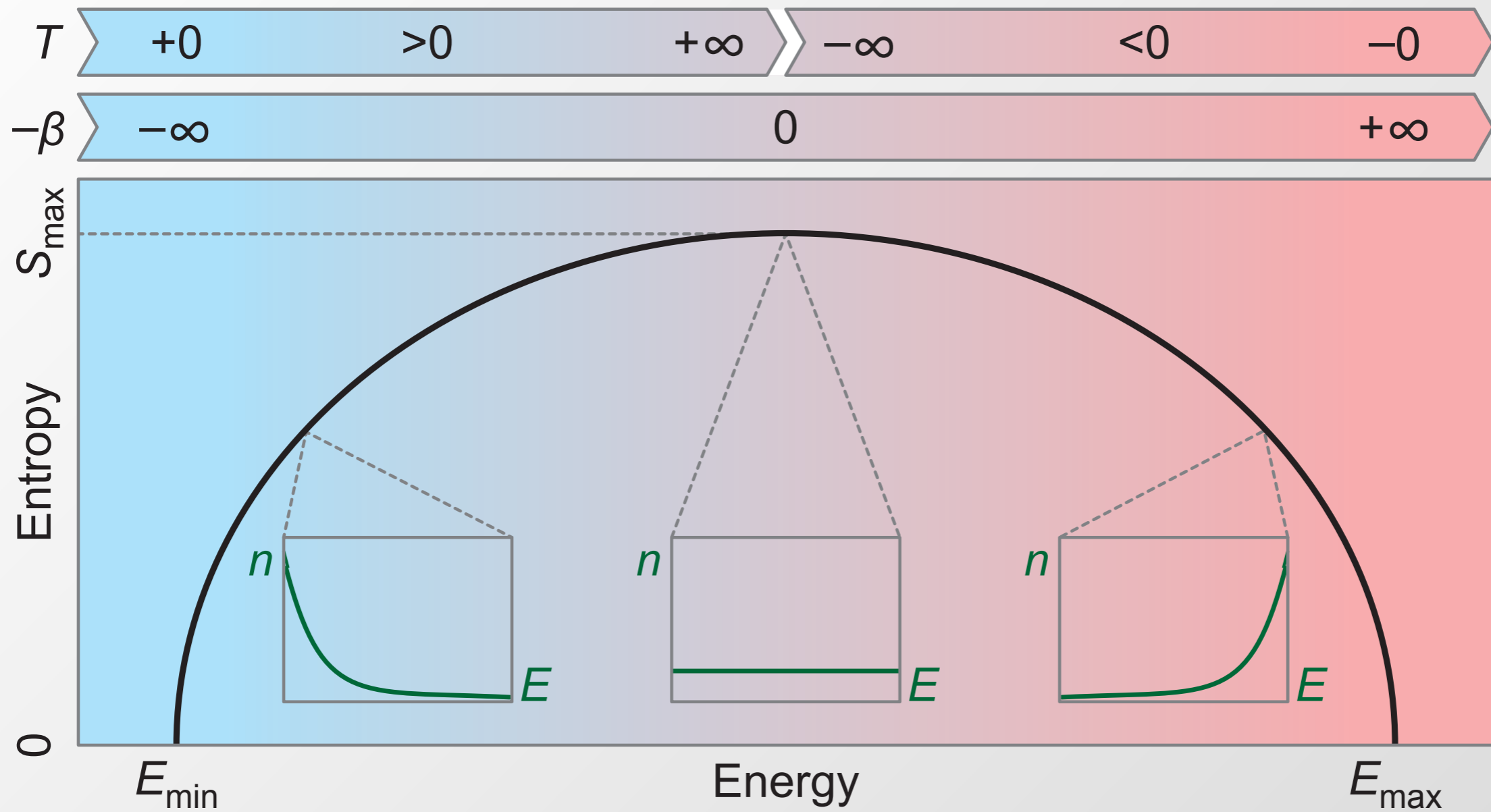

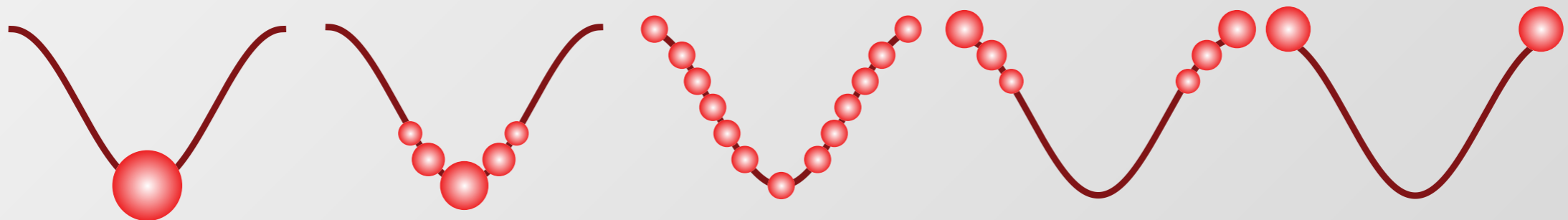
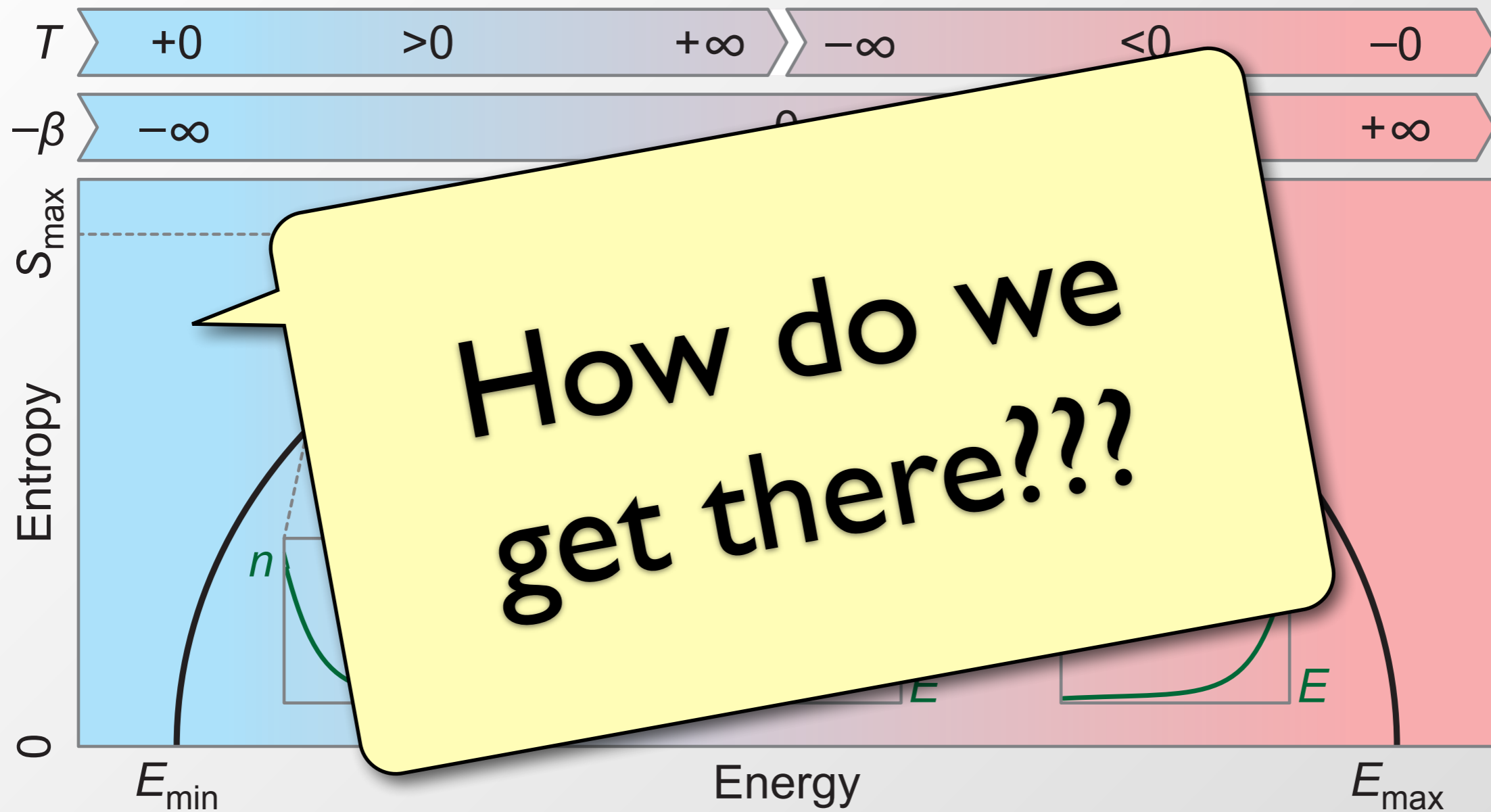

Superfluid

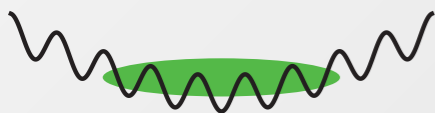
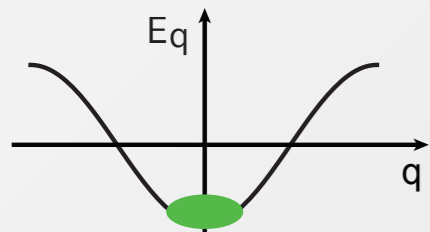

$$T, U, V > 0$$

Sequence: A. Rapp, S. Mandt & A. Rosch, PRL (2010)

Mott Insulator

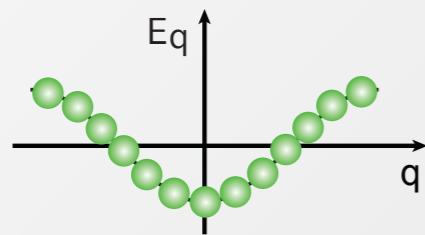

Superfluid

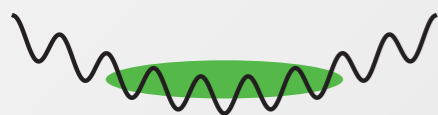
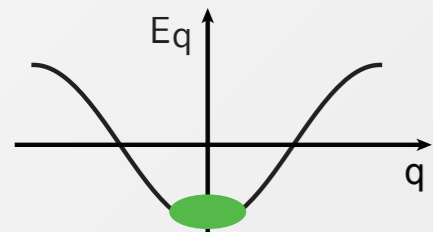
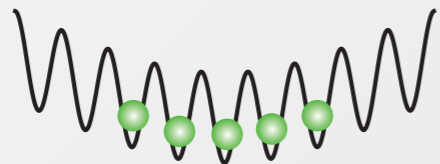

$T, U, V > 0$

Sequence: A. Rapp, S. Mandt & A. Rosch, PRL (2010)

Atomic Limit
Mott Insulator

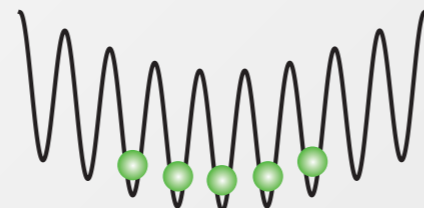
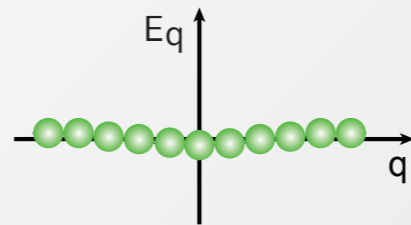

Mott Insulator

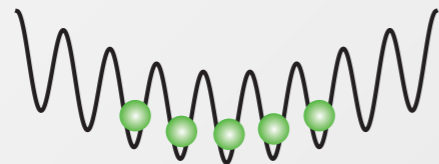
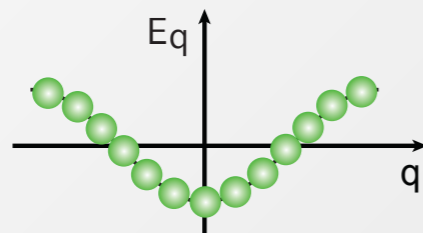

Superfluid

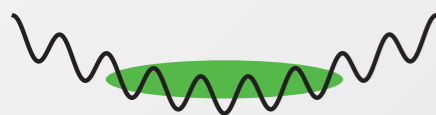
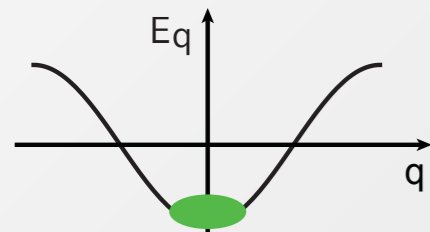

$T, U, V > 0$

Sequence: A. Rapp, S. Mandt & A. Rosch, PRL (2010)

$U \rightsquigarrow -U \quad V \rightsquigarrow -V$

*Atomic Limit
Mott Insulator*

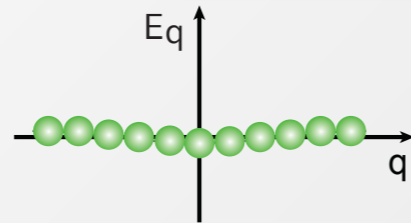

*Atomic Limit
Mott Insulator*

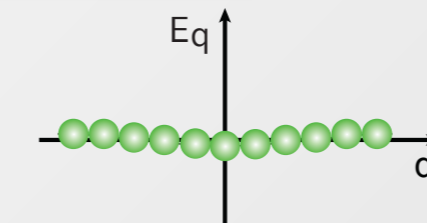

Mott Insulator

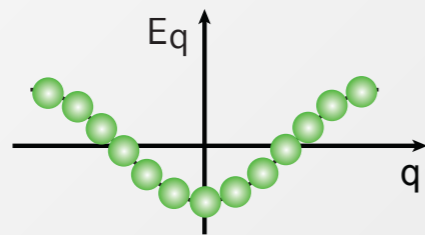
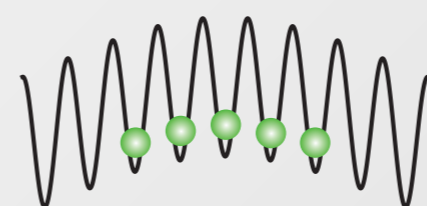
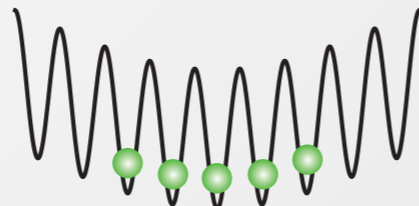

Superfluid

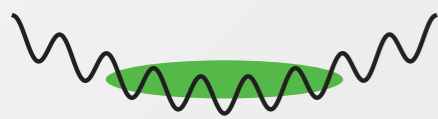
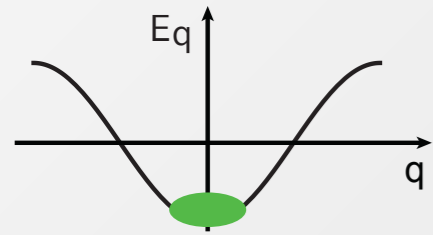
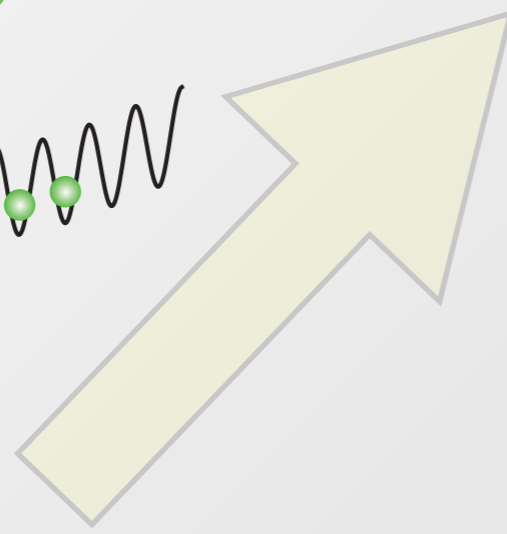
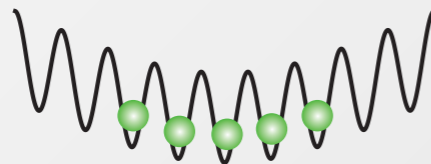

$T, U, V > 0$

$U \rightarrow -U \quad V \rightarrow -V$

Atomic Limit
Mott Insulator

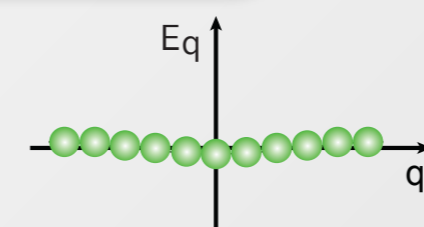
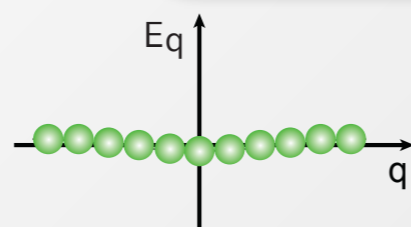

Atomic Limit
Mott Insulator

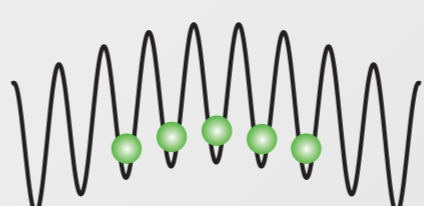
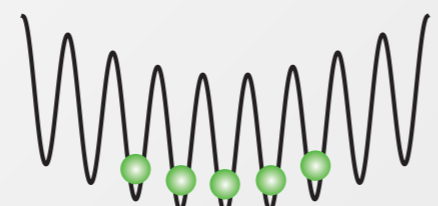

Mott Insulator

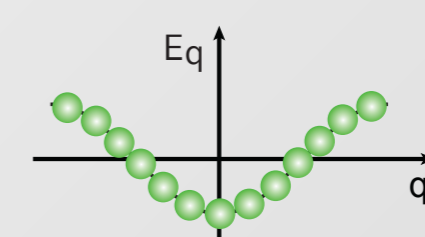
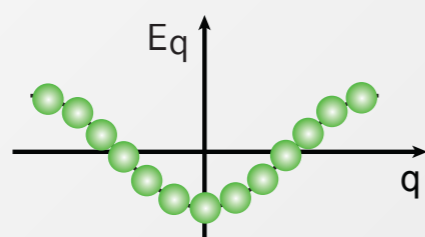

Mott Insulator

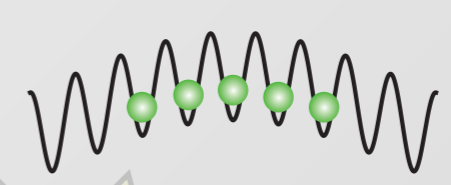
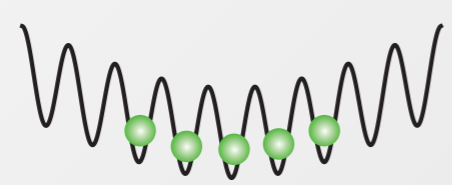

Superfluid

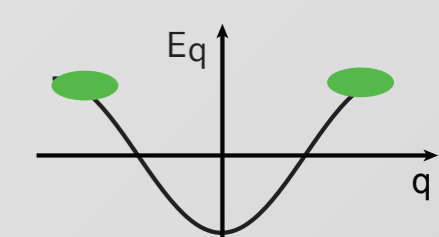
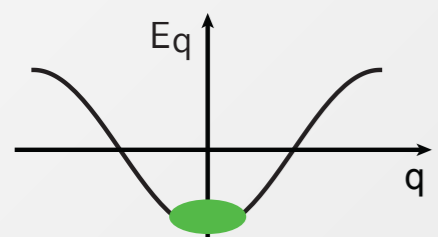

Superfluid

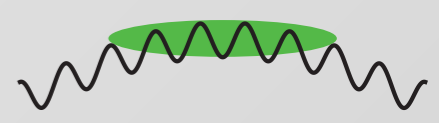
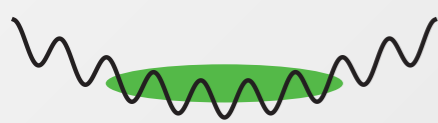

$T, U, V > 0$

$T, U, V < 0$

Sequence: A. Rapp, S. Mandt & A. Rosch, PRL (2010)

SF to MI

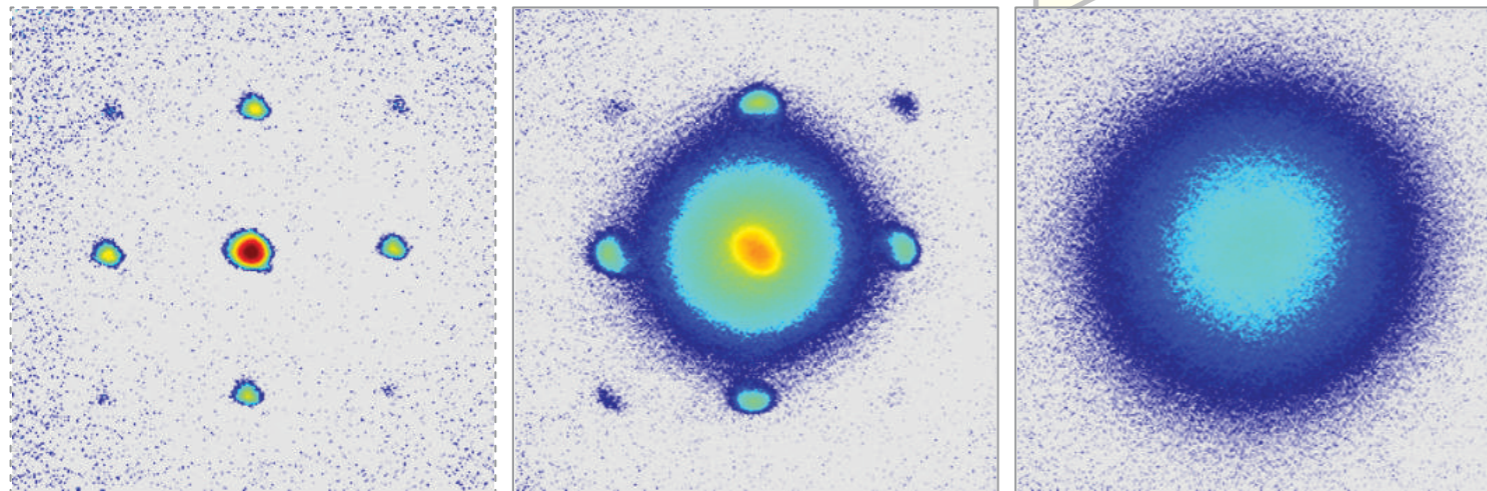

SF to MI

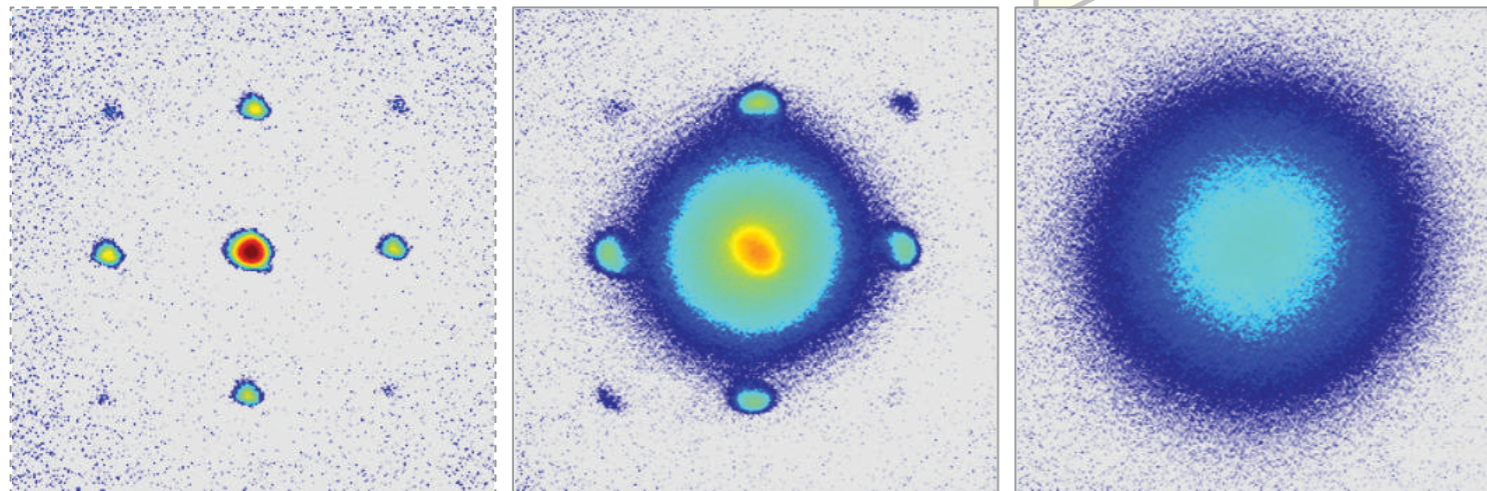

Positive Temperature w/o switching

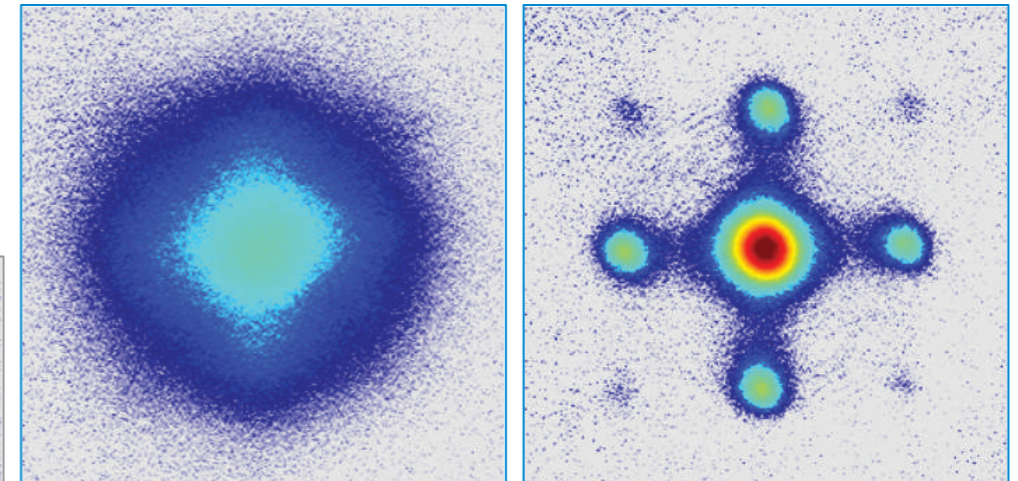

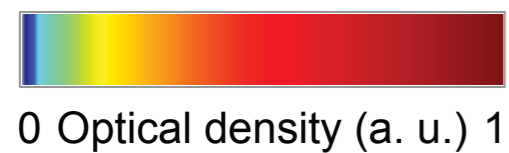
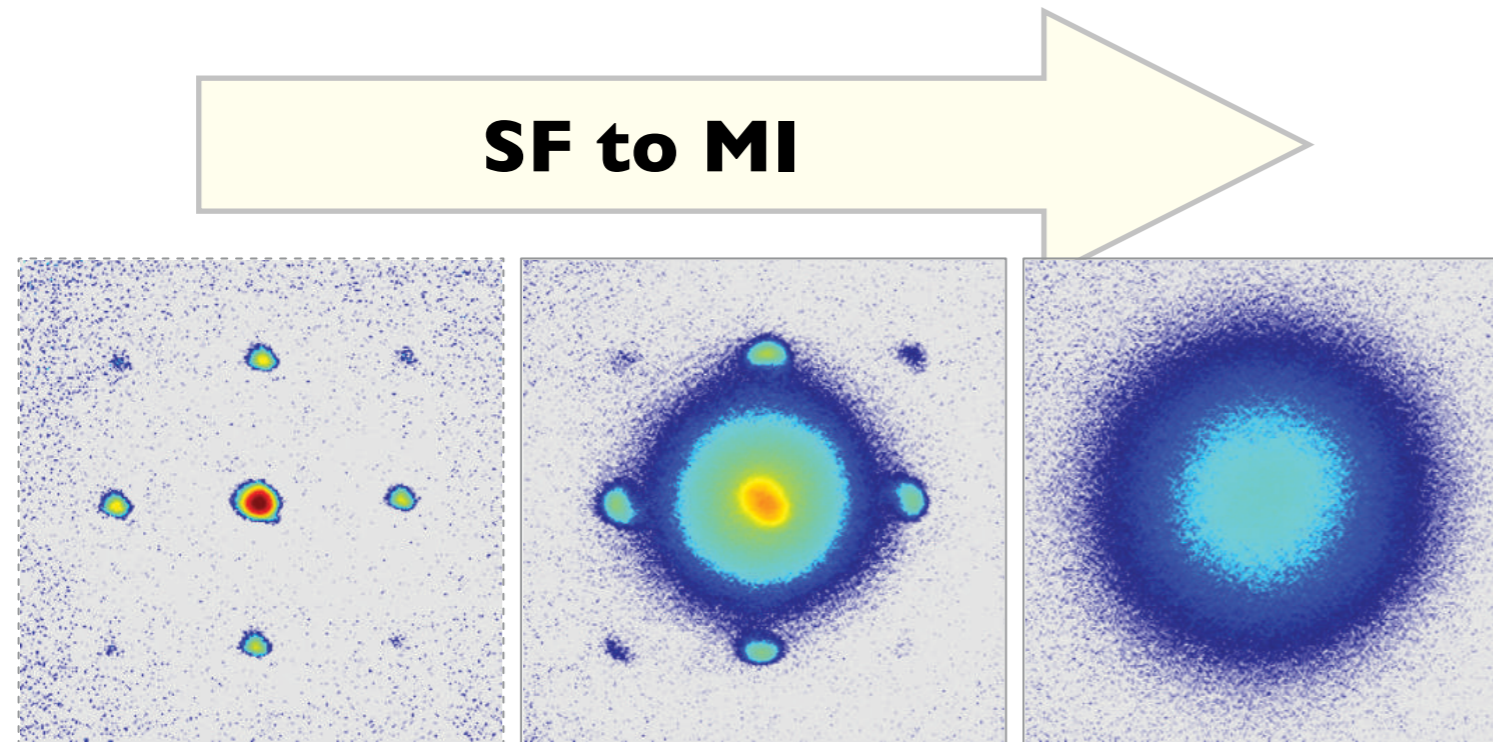

Positive Temperature w/o switching

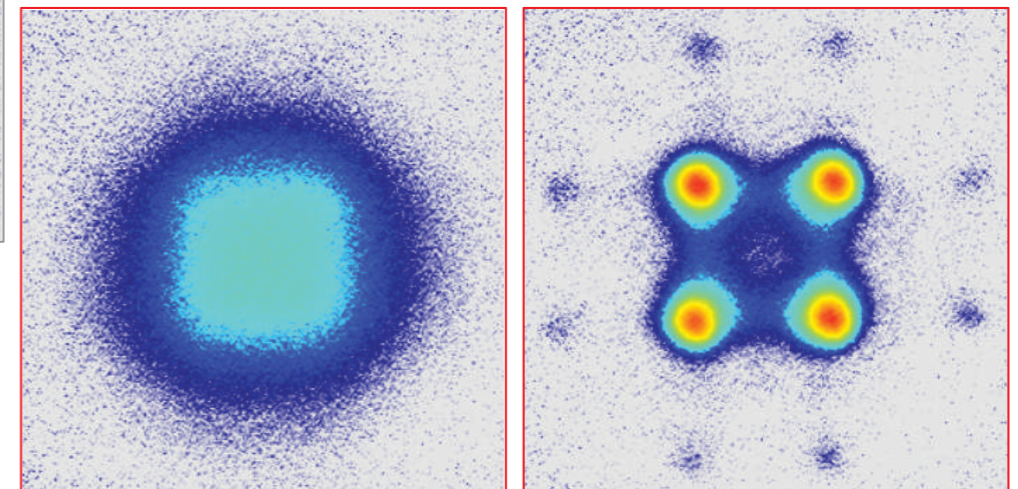
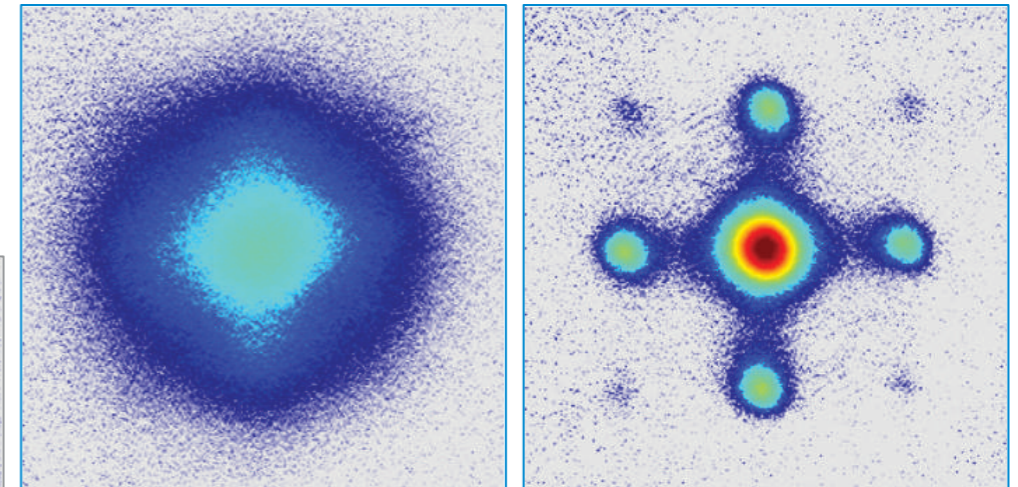

Negative Temperature w switching

For attractive interactions ($a < 0$), **condensate collapses!**

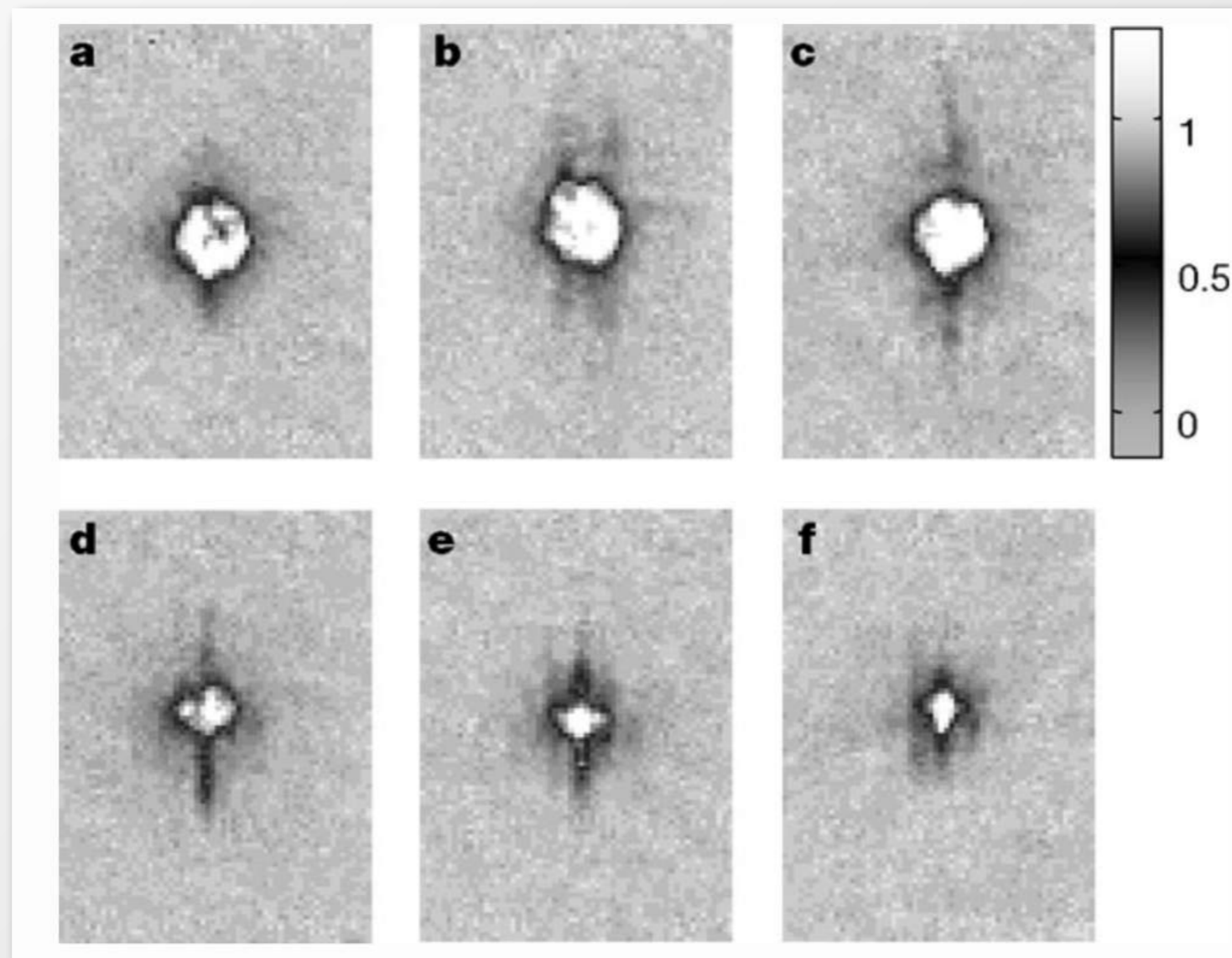

E.A. Donley et al. *Nature* **412**, 295-299 (2001)

J. M. Gerton et al. *Nature* **408**, 692 (2000)

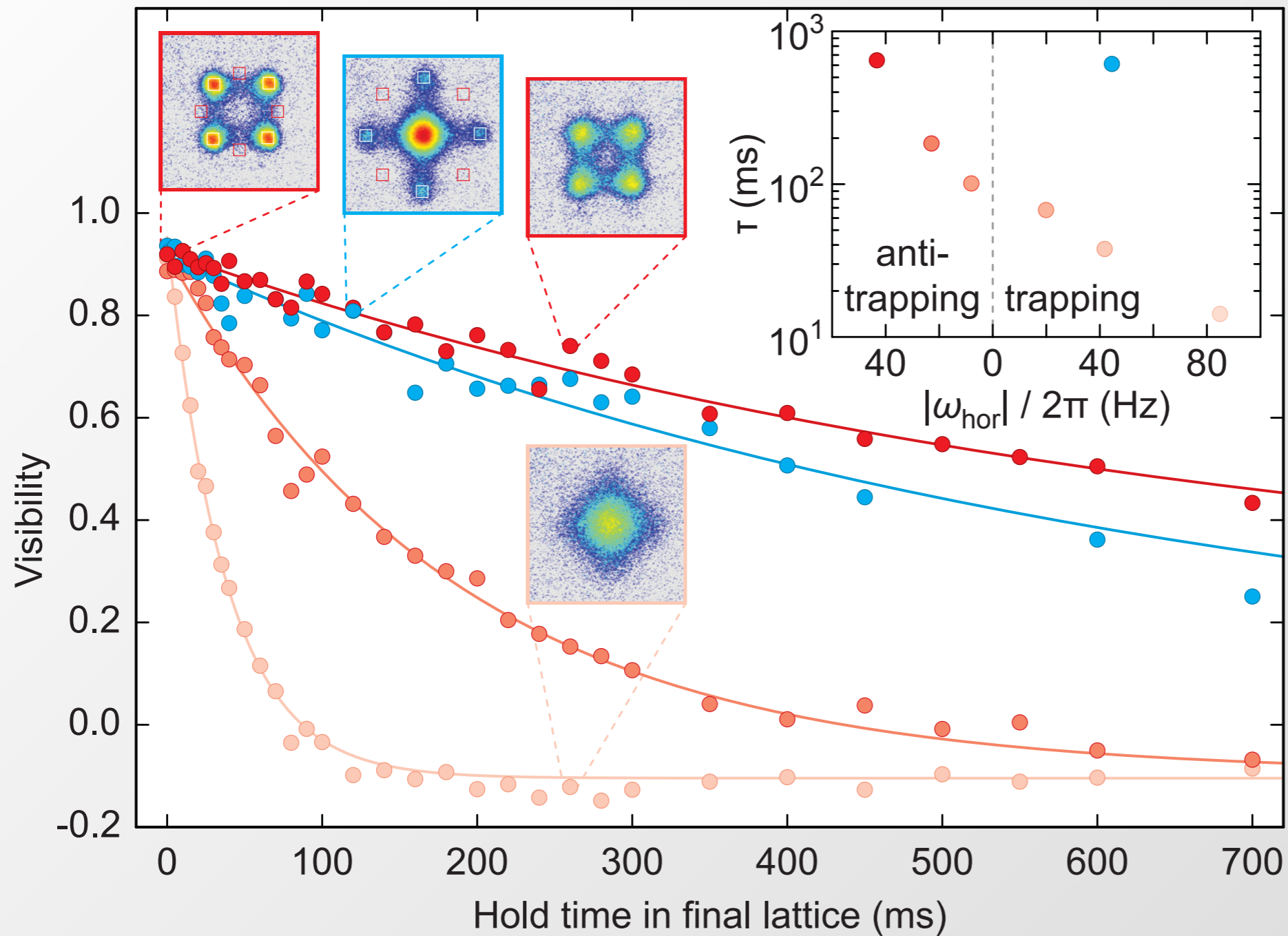

Negative Temperature State as Stable as Positive Temperature State!



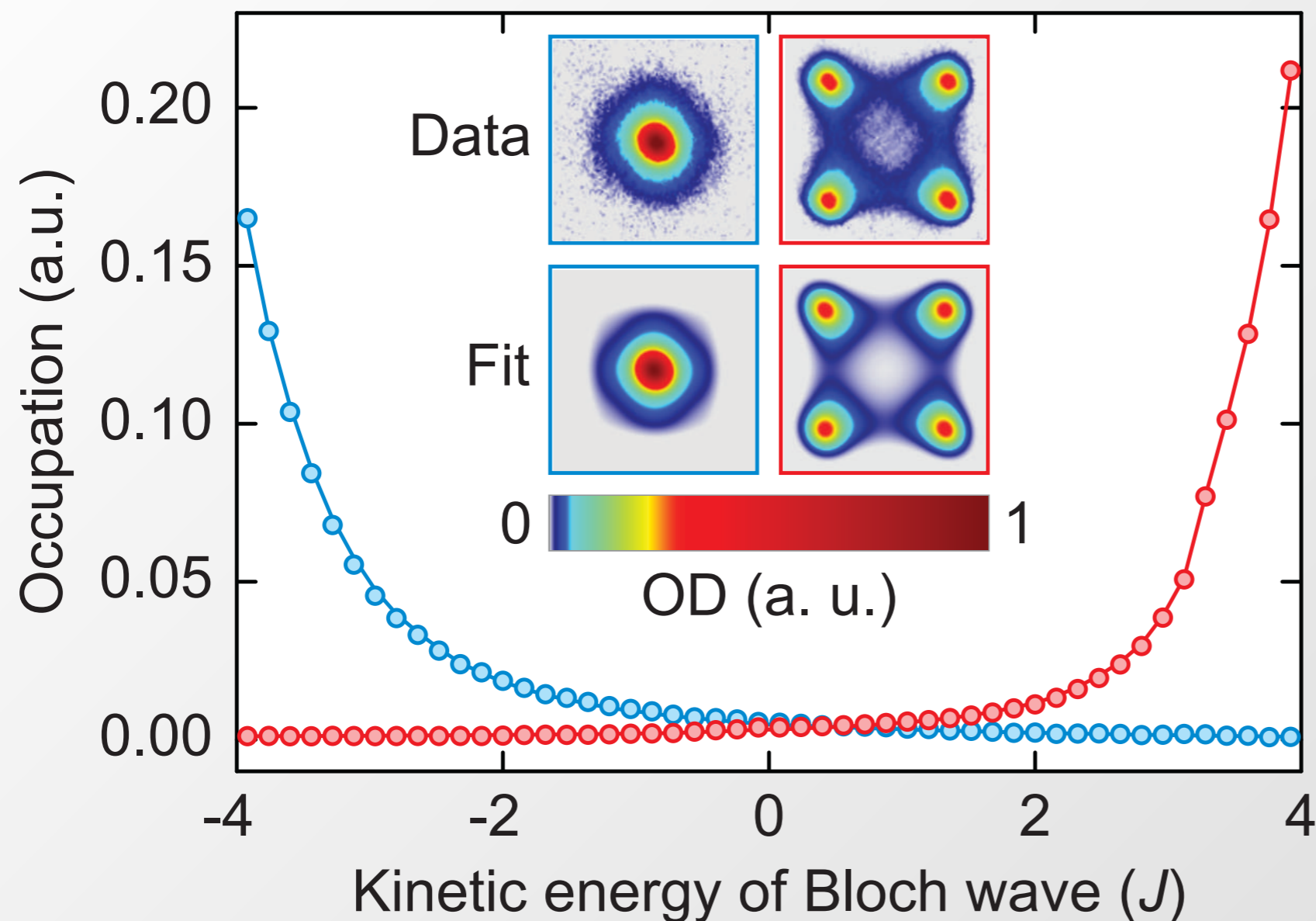

Kinetic energy well
fitted by Bose-Einstein
distribution

$$n(q_x, q_y) = \frac{1}{e^{(E_{kin}(q_x, q_y) - \mu) / k_B T} - 1}$$

$$E_{kin}(q_x, q_y) = -2J [\cos(q_x d) + \cos(q_y d)]$$

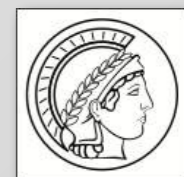

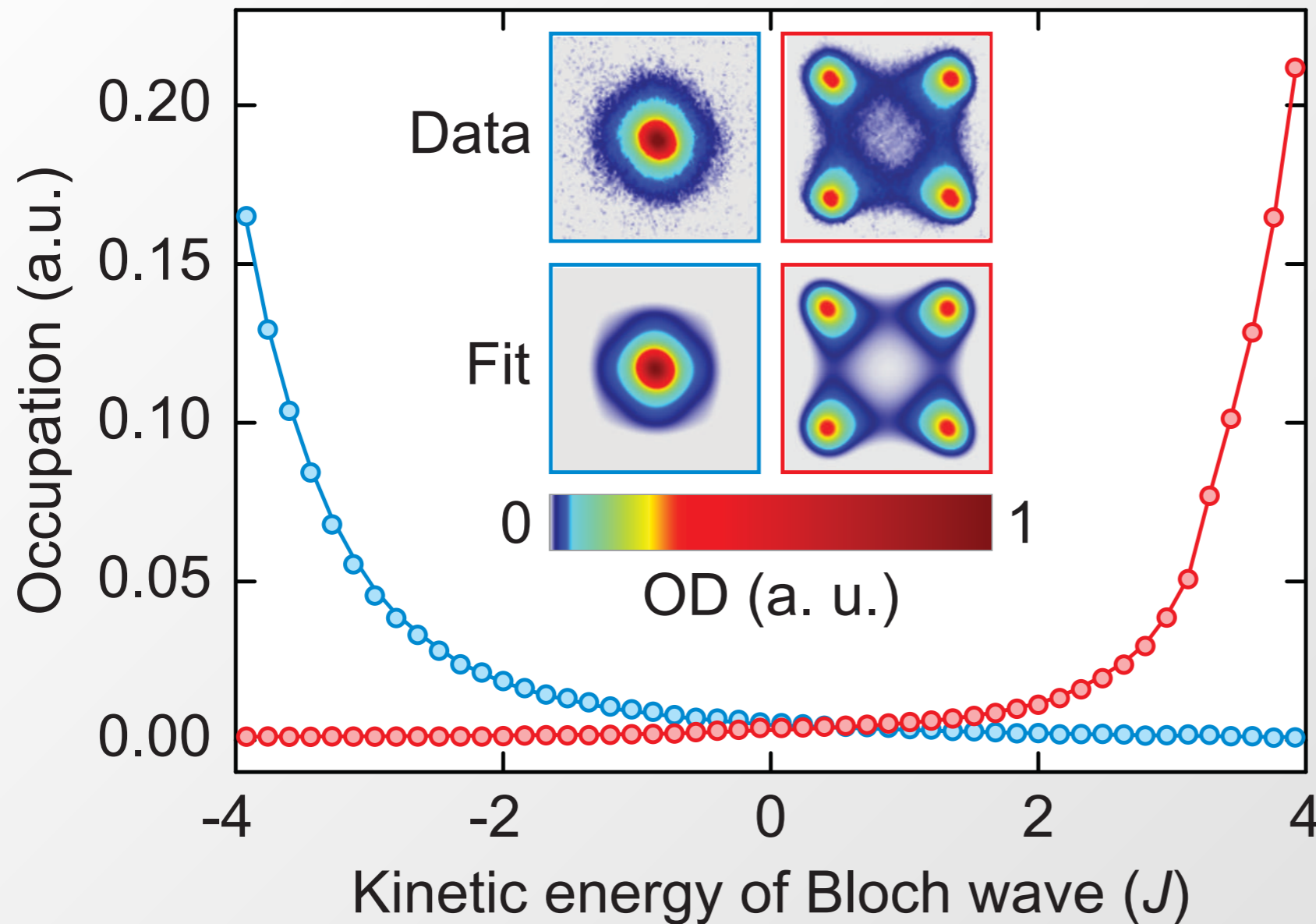

$$T = -2.2J/k_B$$

Kinetic energy well
fitted by Bose-Einstein
distribution

$$n(q_x, q_y) = \frac{1}{e^{(E_{kin}(q_x, q_y) - \mu)/k_B T} - 1}$$

$$E_{kin}(q_x, q_y) = -2J [\cos(q_x d) + \cos(q_y d)]$$



Gases with **negative temperature** possess **negative pressure**!

$$\left. \frac{\partial S}{\partial V} \right|_E \geq 0 \quad \text{and} \quad dE = TdS - PdV$$

$$\Rightarrow \left. \frac{\partial S}{\partial V} \right|_E = \frac{P}{T} \geq 0$$



Gases with **negative temperature** possess **negative pressure!**

$$\left. \frac{\partial S}{\partial V} \right|_E \geq 0 \quad \text{and} \quad dE = TdS - PdV$$

$$\Rightarrow \left. \frac{\partial S}{\partial V} \right|_E = \frac{P}{T} \geq 0$$

Carnot engines **above unit efficiency!** (but no perpetuum mobile!)

$$\eta = \frac{W}{Q_1} = 1 - \frac{T_2}{T_1}$$



Gases with **negative temperature** possess **negative pressure!**

$$\left. \frac{\partial S}{\partial V} \right|_E \geq 0 \quad \text{and} \quad dE = TdS - PdV$$

$$\Rightarrow \left. \frac{\partial S}{\partial V} \right|_E = \frac{P}{T} \geq 0$$

Carnot engines **above unit efficiency!** (but no perpetuum mobile!)

$$\eta = \frac{W}{Q_1} = 1 - \frac{T_2}{T_1}$$

Some statements for the second law of thermodynamics become invalid!



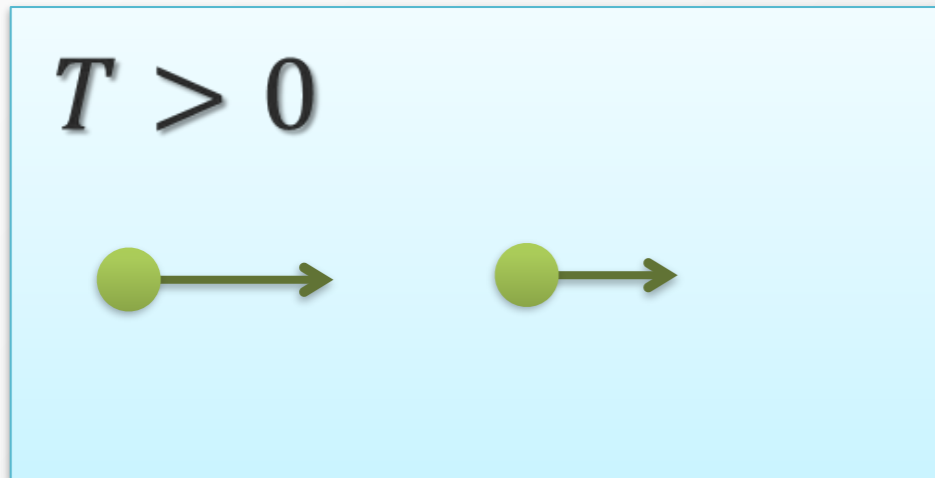

Friction:

- ▶ entropy increases
→ Medium heats up
- ▶ Particle slows down

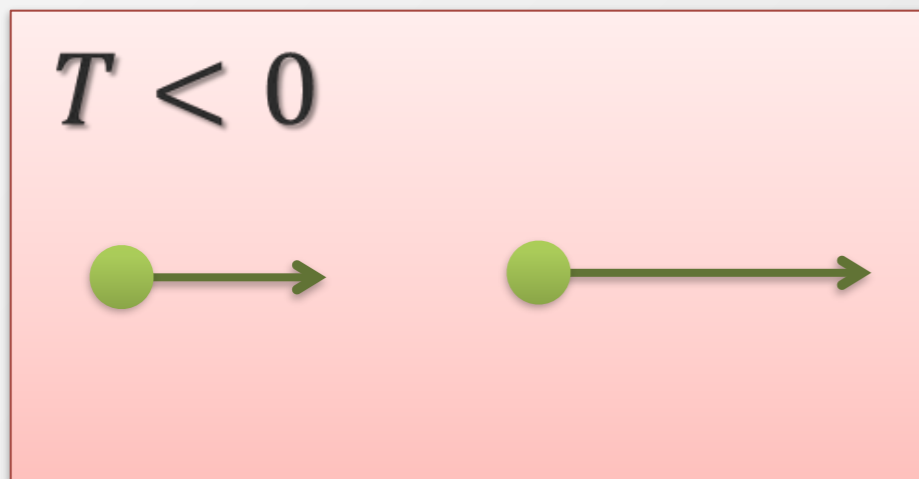

Anti-Friction:

- ▶ entropy increases
→ Medium **cools down**
- ▶ Particle **accelerates**

(but direction is randomized
in long-term limit)

particle spectrum is
assumed to be unbounded



Search



Listen to Fox News Radio Live >

Home Video Politics U.S.

Science Home Archaeology Air & Space

Science gets cold

By Charles Choi / February 24, 2013



WIRED

GEAR SCIENCE ENTERTAINMENT BUSINESS SECURITY DESIGN OPINION VIDEO



SCIENCE

MAIN MENU MY STORIES: 25 FORUMS SUBSCRIBE JOBS SEARCH LOG IN

SCIENTIFIC METHOD / SCIENCE & EXPLORATION

Quantum
Absolute
BY WIRED

Entropy drop: Scientists create "negative temperature" system



Negative Temperatures That Are Hotter Than The Sun

January 04, 2013 1:21 PM



Listen to the Story
Talk of the Nation

Science

MAGAZINE OF THE SOCIETY FOR

Explore

LATEST

NEWS
Hottest temperature ever measured is a negative one
BY ANDREW GRANT 10:38PM, JANUARY 4, 2013

VIEWS

SCIENCE TICKER
Transport method within cells wins Nobel Prize in Medicine or Physiology

mea

Ultracold gas sets
BY ANDREW GRANT 10:38PM,
Magazine issue: February

Home News & Comment

News & Comment News 2013

6 min 31 sec

+ Playlist
↓ Download

NATURE | NEWS

Quantum gas goes below absolute zero



Uncertain **PRINCIPLES**

with **CHAD ORZEL** 

PHYSICS, POLITICS, POP CULTURE

What Does "Negative Temperature" Mean, Anyway?

Posted by **Chad Orzel** on January 8, 2013

 (10)
  Like 45
  Tweet 31
  +1 58
  [More »](#)



3, 2013

Temperature?

...ence is measured in Kelvins (K) ...

... has an article entitled "Ne..."

... potassium ions th...

American Physical Society Sites: [APS](#) | [Journals](#) | [PhysicsCentral](#) | [Physics](#)

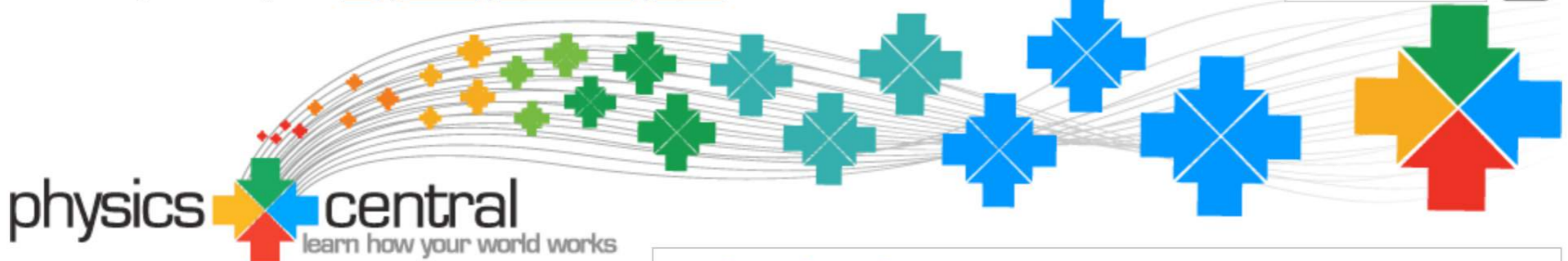

[Explore the Science](#) • [Ask & Experiment](#) • [Physics Buzz](#)

Explore the Science

- Physics in Action
- Physics +

Below Absolute Zero: Negative Temperatures Explained

Absolute zero, or 0 degrees Kelvin, is the temperature where all motion stops. It's the lowest limit on the temperature scale, but recent news articles have heralded a dip below that limit in a physics lab. Is absolute zero less absolute than we thought? Read on to find out.

Latest from Physics in Action

[Element 115 and the Island of Stability](#)

Ununpentium, the



12:16 / 13:16

⏪ ⏩ 🔊 📺 ⚙️ 📱 🗨️ 🗲

Negative Temperatures are HOT - Sixty Symbols

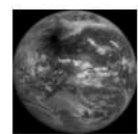

Sixty Symbols ✓

[Subscribe](#) 619,464

783,645 views

+ Add to ➔ Share ⋮ More

👍 12,308 🗨️ 311